

PW250 User Manual

M-Bus levelconverter and repeater for
250 devices



Table of contents

1. Main Features	3
2. Installation	3
2.1 Mounting	3
2.2 Connectors in the terminal compartment	4
2.3 Interfaces at the housing	4
2.4 LED indicators	5
3. Description of functions.....	6
3.1 Interface multiplexer / switch	6
3.2 RS232C interfaces	6
3.3 RS485 interface	7
3.4 Repeater interface	7
3.5 USB interface	8
3.6 Ethernet interface	9
3.6.1 IT preparations	9
3.6.2 Software installation	10
3.6.3 Setup of the device server	11
3.6.4 Setup of the virtual port	13
4. Technical data.....	15
4.1 General data	15
4.2 Interface data.....	16
4.3 Ordering information	16

© Relay GmbH 2023

www.relay.de

1. Main Features

- M-Bus Level Converter for 250 devices
- Transparent level converting of several interfaces to M-Bus
- Ethernet 10/100BaseT and USB 2.0 with driver for virtual serial port
- 1 x RS232C with terminals (TXD, RXD, GND) and 1 x RS232C with DSUB socket
- 2-wire RS485 interface (not addressable)
- M-Bus Booster with Repeater function for extension of M-Bus networks
- Galvanic isolation of all interfaces from M-Bus
- Intelligent access control of the interfaces by a microcontroller
- Internal power supply with wide range input for worldwide use
- Housing for wall mounting (optional rail mounting kit)

2. Installation

2.1 Mounting

The case of the PW250 can be attached to a wall with four screws. The drill pattern is rectangular (180 mm horizontal, 180 mm vertical). The drillings shall have a diameter of 5 mm. You can alternatively fix a special rail holder to the case to enable the mounting on a rail of the type TS 35 (Accessory: GHZ TSH35-2). The case can be secure closed with the optional cylinder lock (accessory: GHZ Lock).

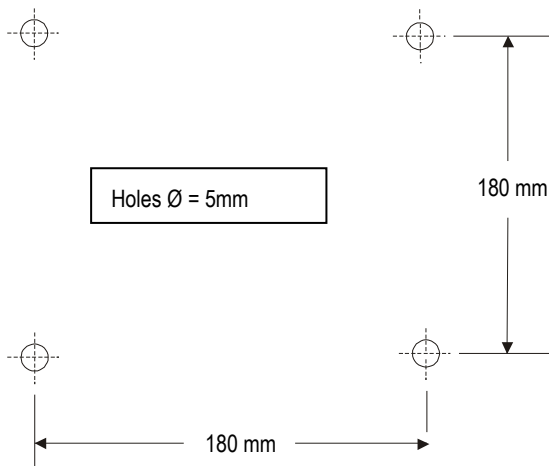

2.2 Connectors in the terminal compartment

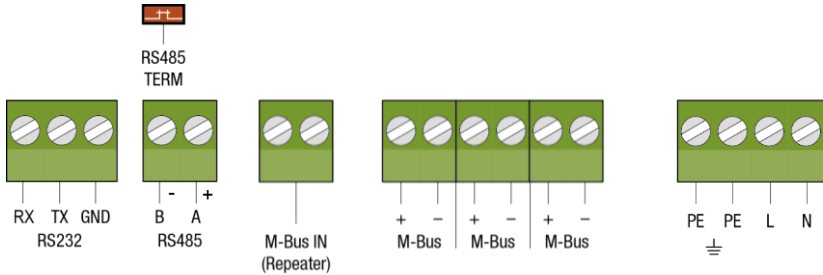

PE / PE	Protective conductor (earth)
L / N	Main power supply 110VAC to 240 VAC, to be connected only by electricians
M-Bus + -	M-Bus output, wires to the M-Bus meters, 3 pairs of parallel connections
M-Bus IN Repeater	M-Bus Repeater input for network extension
RS485 A B	RS485 interface, 2-wire, A = + / B = -
RS485 Term	Terminator for RS485 interface, jumper placed (default) = 120 Ω
RS232 RX,TX,GND	RS232C interface, RX = PC receives data, TX = PC transmits data, GND

Attention: When laying the cables in the terminal compartment, please take care that the light pipes are not blocked by cables after closing the housing cover.

2.3 Interfaces at the housing

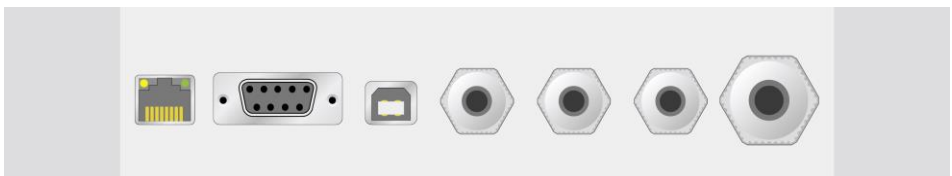

Ethernet

RS232C

USB

Cable glands

Ethernet

10/100MBit RJ45 Ethernet socket for network connection

RS232

RS232C D-SUB9 socket

USB Device

USB connector of the internal USB-to-RS232 converter (FTDI).

Cable glands

for power supply, M-Bus, RS232C, RS485 and M-Bus IN

2.4 LED indicators

There are in total six LEDs in the front part showing the status of the M-Bus. A lighted LED has the following meaning:



POWER		The M-Bus output voltage is switched on.
TRANSMITTING		The Master sends data.
RECEIVING		Minimum one meter replies with data.
MAX CURRENT		The maximum number of connectable meters is exceeded (warning).
SHORT CIRCUIT		M-Bus over current / short circuit (2 Hz flashing)
M-Bus ACTIVE		One interface is active and exclusively occupies the M-Bus.

Two LEDs in the RJ45 Ethernet socket show the state of the network and the virtual comport. The LEDs have a reduced intensity of 20% of the normal value without a connected network cable. Once a network is connected, the brightness changes to 100%. The most important flash patterns have the following meaning:

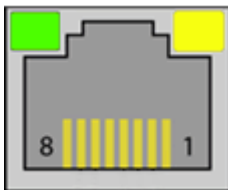

	No connection established
	A connection is active
	A connection is established and a communication is active
	Device Server performs a restart

You can find all other patterns in the online help of the DS Manager (F1-button) in the chapter "Firmware Manuals / Device Server Application Firmware / Status LED Signals (Red = Green / Green = Yellow).

3. Description of functions

The PW250 is a transparent Level Converter from several interfaces to M-Bus for up to 250 meters. The device allows external connected controllers such as a building control, a DDC or a PC to read the connected meters by use of an M-Bus software (not in scope of delivery). The PW250 can also be used as a Repeater for extension of M-Bus networks relating to the cable length and number of meters.

3.1 Interface multiplexer / switch

An internal microcontroller handles the bus control to just give one interface access to the M-Bus even with multiple connected interfaces. This ensures that systems do not interfere with each other during the communication, when two or more systems are connected, for example a BMS via RS485 and a PC via USB. This automatic switch operates on the principle "first come, first served", i.e. when an interface sends a signal to the M-Bus, this interface takes control of the M-Bus and has exclusive access to communication. The "ACTIVE" labeled LED indicates the activity status of the internal interface switch. While the LED is lit, one of the six possible interfaces is active. The other interfaces are disabled at this time and cannot access the M-Bus. The active interface remains enabled about 3 seconds after the last communication. Another interface can occupy the M-Bus as soon as the LED goes off.

3.2 RS232C interfaces

The PW250 has two independent RS232C interfaces, one of them as a 9-pin D-SUB socket in the case front and the other as a 3-pin screw terminal in the terminal compartment. The RS232C pins assignments are:

RX = PC transmits to M-Bus, TX = PC receives from M-Bus, GND = Signal ground

The pin assignments of the D-SUB socket (female) are designed so that for connection to a PC a simple 9-pin extension cable (male / female with 1: 1 connection) can be used.

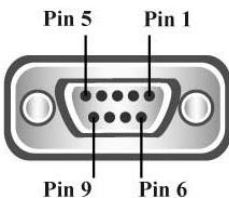

Pin 1	DCD (data carrier detect)	Unused
Pin 2	RXD (PC receives data)	M-Bus transmits data to PC
Pin 3	TXD (PC transmits data)	PC transmits data to M-Bus
Pin 4	DTR (data terminal ready)	Bridged to Pin 6 (DSR)
Pin 5	GND (Signal ground)	GND
Pin 6	DSR (date set ready)	Bridged to Pin 4 (DTR)
Pin 7	RTS (request to send)	Bridged to Pin 8 (CTS)
Pin 8	CTS (clear to send)	Bridged to Pin 7 (RTS)
Pin 9	RI (ring indicator)	Unused

3.3 RS485 interface

A 2-wire RS485 interface will be connected to the RS485 terminals (A = + and B = -) in the terminal compartment. Please note that this is a transparent interface without addressing on the RS485 bus. The direction control of the half-duplex 2-wire connection is realized that the PW250 is passive in the idle state (receiver on, transmitter off) and becomes on transmitted data from M-Bus meters (receiver off, transmitter on). The level converter remains active on the RS485 for approximately 50ms after the last transmitted space (0-Bit) of the slave. The master software should not start a new request to the connected meters during this period.

The RS485 bus is terminated at the factory with a 120Ω resistor. This can be disabled if necessary by removing the jumper "RS485 TERM" on the board in the terminal compartment. The terminating resistor is designed for permanent overvoltage up to a value of 7 VDC on the RS485 bus. If a higher overvoltage protection is required, the jumper should be removed and a proper dimensioned external resistor be connected between terminals A and B.

3.4 Repeater interface

The PW250 can be used as a so-called Repeater, as a network extension for existing M-Bus systems, if the maximum number of meters or the maximum cable length has been exceeded for the installation. Up to 250 devices and up to 4km cable (1 x 2 x 0.8 JYSTY) at 2400 baud transmission speed can be connected to a repeater.

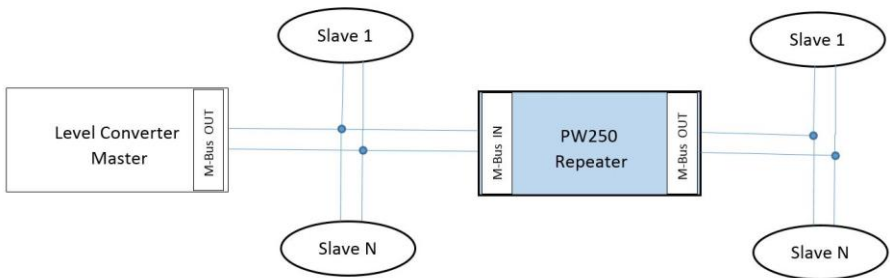

The M-Bus line of the existing master or level converter is connected to the terminals labeled with M-Bus IN (Repeater). The polarity does not matter - as usable and standardized for M-Bus slaves. The signal at the M-Bus output of the PW250 is reconditioned to connect a complete M-Bus network. An almost unlimited number of repeaters can be cascaded or connected in parallel due to the automatic measurement of the maximum transmission speed and the recovery of bit times (bit recovery) by the digital repeater. This allows nearly unlimited M-Bus networks.

3.5 USB interface

The USB device port of the PW250 is as a USB 2.0 connector type B available on the front of the housing. Please use a USB cable with a type A plug on one end and a type B plug on the other side (not supplied) to connect a PC. You must install the software driver for the virtual COM port before you can use the USB interface. This simulates a serial port that you can use as usual in your M-Bus software. You can find the driver on our CD "Tools & Docs", on our homepage www.relay.de or directly from FTDI Chip, the manufacturer of the used USB chip: <https://ftdichip.com/drivers/vcp-drivers> (here you will also find drivers for Linux and Mac OS). Please unpack the ZIP file after download. Install the drivers by clicking on the unzipped file in the File Explorer with the right mouse button and select the menu item "Run as administrator" (example file name is: CDM212364_Setup.exe).

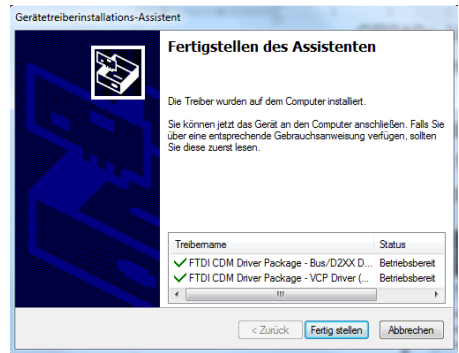
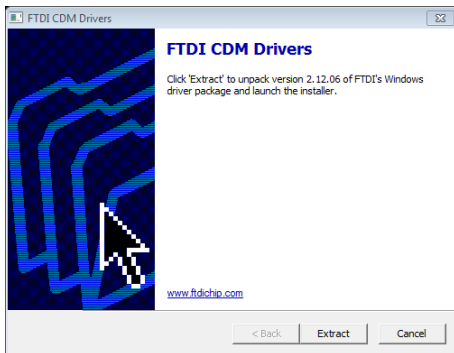

Now you can connect the PC. The USB driver for the PW250 is installed automatically and generates a new, virtual COM port. The new COM port number of the USB serial port is displayed after the installation is finished (here: COM29). You can look up this number at any time in the Device Manager under ports (USB Serial Port) and - if desired - change it in the advanced settings of the driver. Please select the appropriate comport number in your M-Bus software.

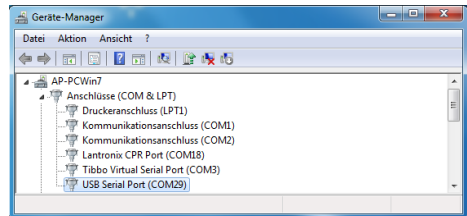
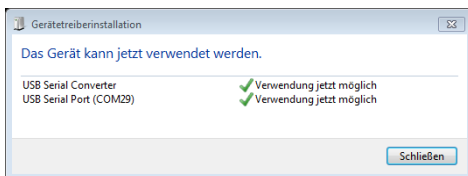

3.6 Ethernet interface

The Ethernet interface of the PW250 converts the physical interface Ethernet 10/100BaseT to M-Bus and the TCP / IP protocol to the serial protocol. The Ethernet interface is available in the front panel as an 8-pin RJ45 socket. The PW250 can be integrated into an existing local network and the M-Bus meters can be read from one or more PCs in that network. This requires the so-called "Tibbo Device Server Toolkit" to be installed on that PC. With this software the Ethernet interface is configured in the PW250 and a virtual COM port is set up. This simulated serial interface enables the use of the usual M-Bus software designed for normal serial interfaces. Please perform the following steps of installation:

3.6.1 IT preparations

The IT division of the network containing the PW250 must define the following items:

- Fixed IP address must be identical to the IP range of the reading computer. Only the last number must be different. (e.g. 192.168.1.239)
- You need also the subnet mask and IP address of the gateway if the IP addresses are reassigned by a gateway.
- The converter uses the port 1001 by default for the TCP protocol. This port must not be blocked by any firewall.

You can find your own IP address in your network this way:

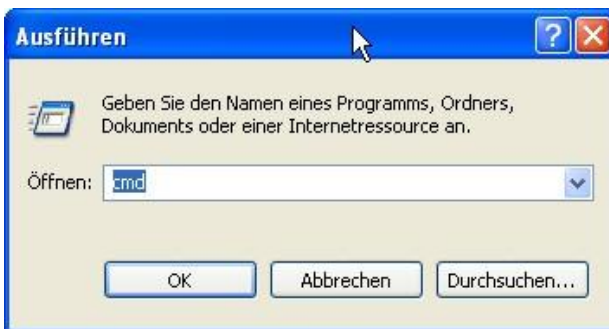

Start – Run: cmd <OK>

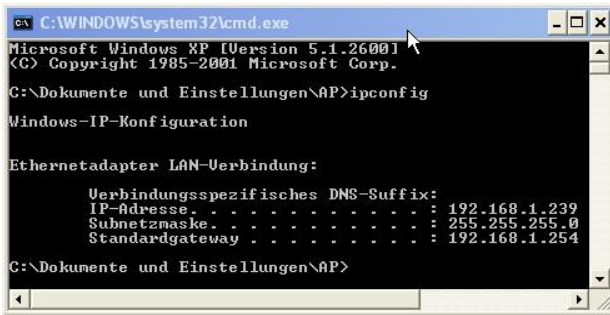

Input: ipconfig <enter>

Own IP address and subnet mask will be shown

3.6.2 Software installation

You can find the driver software on our CD "Tools&Docs", on our homepage www.relay.de or directly at the manufacturer's site: <https://tibbo.com/support/downloads/tdst.html>. Please start depending on your operating system either the 32 bit or 64 bit version of the installation program as an administrator:

tdst_5-14-00-x86.exe (32-Bit Windows) or tdst_5-14-00-x64.exe (64-Bit Windows)

TDST = Tibbo Device Server Toolkit, 5-14-00 = Version 5.14.00 dated August 2021)

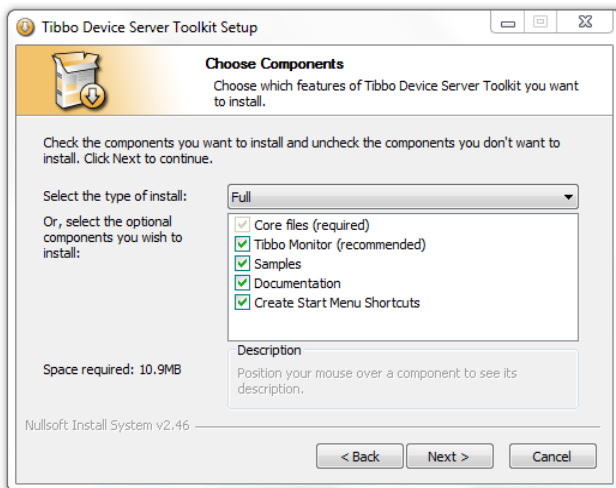

After a reboot of the PC the installation of the drivers and software tools is completed.

3.6.3 Setup of the device server

Please start the Tibbo – DS Manager (Start – Programs – Tibbo – Tibbo Device Server Toolkit -

Tibbo DS Manager.

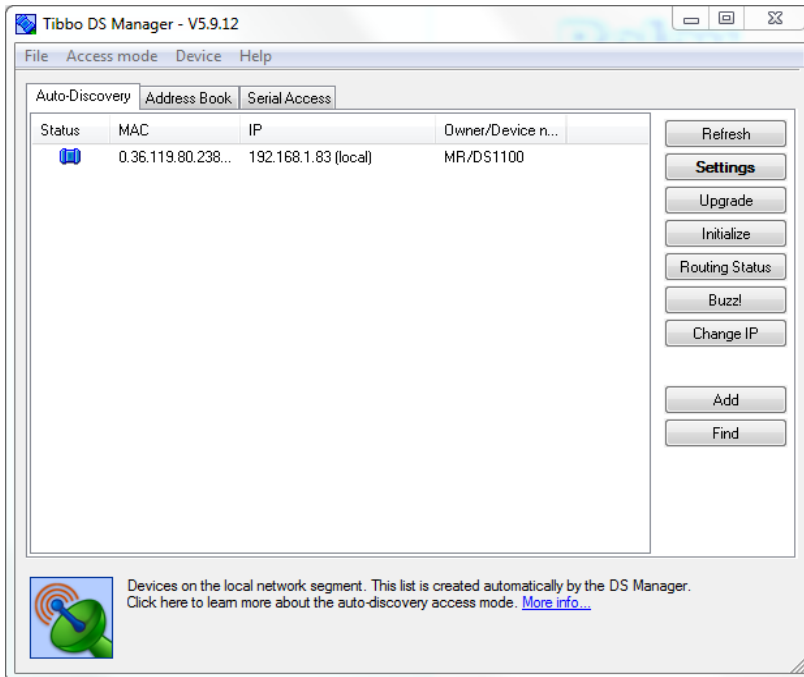

The DS Manager (DS = **D**evice **S**erver) shows all by broadcast detectable device servers in the sheet „AutoDiscovery“. Device servers which are not in the same IP address range will not be found and must be manually added into the sheet “Address Book” (button “Add”). Please select the device which you want to configure and click on the button “Settings”. Then you see the settings of the device which you shall change according to the following pictures. You can get help for the DS Manager with F1 key.

Recommended settings:

The screenshot shows the 'Settings: DS (ds4.33)' window with the following configuration details:

Category	Setting	Value	Marked with Arrow
General	Owner name		
	Device name		
	DHCP	0- Disabled	
	IP-address	192.168.1.83	Yes
	Gateway IP-address	192.168.1.254	
	Subnet mask	255.255.255.0	
Wi-Fi	Wi-Fi Mode	0- Disabled	Yes
	Access Point Name	(irrelevant)	
	Security	(irrelevant)	
	Password	(irrelevant)	
	DHCP	(irrelevant)	
Channel1	IP-address	(irrelevant)	
	Gateway IP-address	(irrelevant)	
	Subnet mask	(irrelevant)	
	Connection timeout (min)	5	Yes
	Transport protocol	1- TCP	Yes
	Broadcast UDP data	(irrelevant)	
	Inband commands	0- Disabled	Yes
	Routing Mode	0- Server (Slave)	
	Accept connection from	0- Any IP-address	
	Port	1001	
	Connection mode	(irrelevant)	
	Destination IP-address	(irrelevant)	
	Destination port	(irrelevant)	
	Notification destination	0- Last port	
	Serial interface	0- Full-duplex	
	RTS/CTS flow control	0- Disabled OR remote	
	DTR mode	0- Idle or remote	
Power-up DTR state	0- LOW		
Baudrate	1-2400bps	Yes	
Parity	1- Even	Yes	
Data bits	1- 8 bits		
Max intercharacter delay	1		
Soft entry into serial program	0- Disabled		
Escape character (ASCII cc)	(irrelevant)		
On-the-Fly commands	1- Enabled		
Password for on-the-Fly con	0- Disabled		
Notification bitmask	0		
Notification destination	0- Last port		

Buttons at the bottom: Save, Load, Password, OK, Cancel

Change values marked with an arrow

OK:

Stores settings and restarts the device

3.6.4 Setup of the virtual port

The next step is the setup of a virtual, serial port in your PC. You don't need the virtual port if the used software offers a TCP/IP port instead of serial ports. In this case you must correctly program all settings of the serial interface like baudrate, parity and data bits. You also don't need a virtual port in the bridge mode (two device servers connected together, i.e. one TCP001 (serial device server) to the PW250).

Please start the Tibbo – DS Manager (Start – Programs – Tibbo – Tibbo Device Server Toolkit – **Tibbo VSP Manager**).

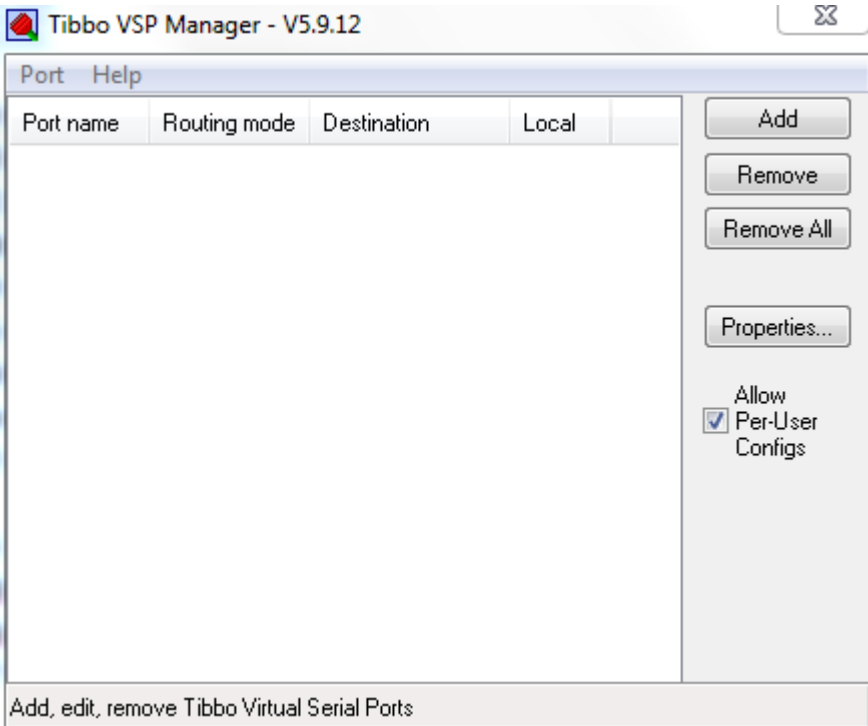

Please add a VSP (virtual serial port) by clicking on the “ADD” button.

Please do the following settings:

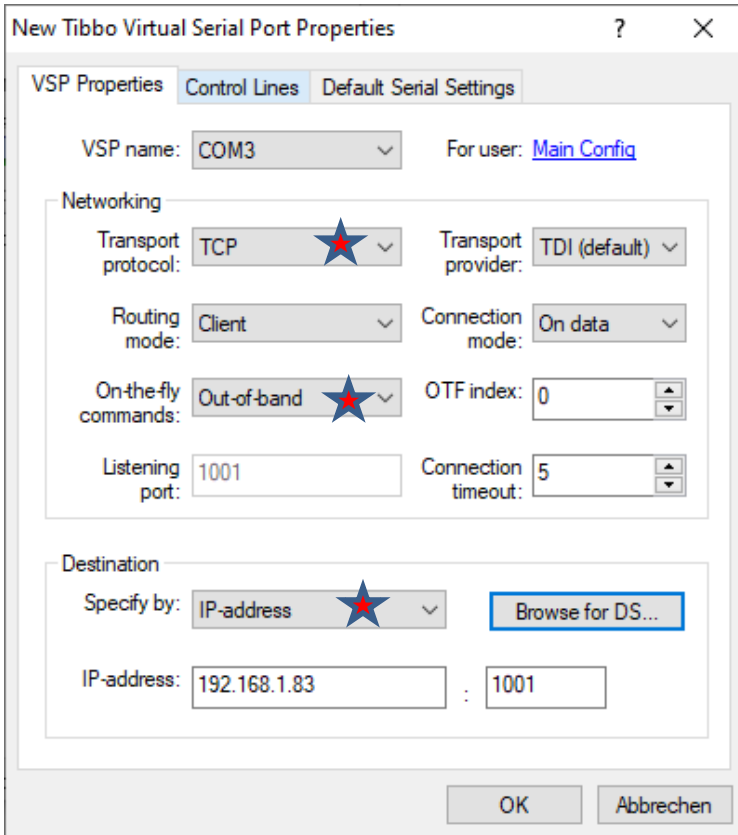

Change marked values

Browse for DS:
Select the device server

Then you can program the values for the serial communication after startup in the sheet “Default Serial Settings” (baudrate, data bits, parity, flow control). A click at „OK“ generates the virtual port and then it can be used in your M-Bus software. Please select the respective port (VSP name) in your software as the communication interface. Now the installation is completed. You can change the settings of the device and the COM port using the DS manager respectively the VSP manager at any time. You can also change the settings of the device server and check its routing state after first setup using a web browser connected to the assigned IP address. The required password for the login is empty on delivery.

4. Technical data

4.1 General data

Operating voltage	110 .. 240 VAC, 47 .. 63 Hz
Power consumption	max. 100W
Operating temperature range	0 .. 45°C
M-Bus voltage	42 V (Mark), 28V (Space)
M-Bus basic current	max. 375 mA
Overcurrent threshold	> 500 mA
Internal bus resistance	8 Ohm
Communication speeds	300 .. 38400 Baud
Bit threshold	typ. 7,0 mA
Collision threshold	typ. 48 mA
Maximum cable length for recommended cable type JYSTY 1 x 2 x 0,8 mm	Total (all wires): 1km (9600 baud), 4km (2400 baud), 10km (300 baud) Max. distance to slave (250 slaves at the end of the cable): 350 m Max. distance to slave (250 slaves equally distributed): 900 m
Galvanic isolation	All interface are isolated from M-Bus and power supply. The Repeater input is additionally isolated from the other interfaces.
Housing	Light-grey ABS plastic, protective class IP52 H x W x D: 229 x 204 x 76 mm Mounting on a rail or wall, optional cylinder lock
LED indicators	Power, communication master, slave, warning, short circuit M-Bus, M-Bus activity
Interfaces	10/100 Mbit Ethernet, USB device, RS232C (SUB-D9), RS232C (terminals), RS485, Repeater (M-Bus IN)
Terminals	3 pairs screw terminals for M-Bus, 3-pin screw terminal for RS232C, each 1 pair screw terminals for RS485 and Repeater, 4-pin screw terminal for power supply

4.2 Interface data

RS232C	Driver load	Current max. 5mA, resistive: min. 3k Ω , capacity: max. 2,5 nF
	Voltage transmit (at 3k Ω)	Mark: $+5V \leq U_T \leq +15V$ Space: $-15V \leq U_T \leq -5V$
	Voltage receive	Mark: $+2,5V \leq U_R \leq +15V$ Space: $-15V \leq U_R \leq -2,5V$
RS485	Driver load	Current max. 250 mA, resistance min. 54 Ω
	Signal voltage TX	Space (0): $+1.5V \leq U_t \leq +5.0V$ Mark (1): $-5.0V \leq U_t \leq -1.5V$
	Addressing	Not possible (transparent)
Repeater	Current M-Bus IN	Basic current < 1,5 mA (1 Unit Load), TX current typ. 15mA
	Capacity	Max. 250 pF
	Galvanic isolation	> 2,5 kV to all interfaces, M-Bus and power supply
USB	Type	USB 2.0 device, socket type B
	USB IC	FTDI Chip: FT232R, Vendor ID = 0403, Product ID = 6001
	Power supply	Bus powered, Low Power (max. 90mA)
Ethernet	Network interface	10/100BaseT (RJ45), auto-MDIX, with 2 LEDs
	Protocols / addressing	TCP and UDP / static IP or dynamic IP (DHCP)

4.3 Ordering information

Article number	Description
PW250	M-Bus Level Converter and Repeater for 250 slaves
KA003	Power cable 2m, with German plug according to CEE 7/4, grey
KA USB AB	USB cable A to B plug/plug, length = 1m, grey
KA PATCH.5E RJ45 1M	Network patch cable CAT5E FTP, Length = 1m, grey
GHZ TSH35-2	Rail mounting set TH35 incl. screws
GHZ Lock	Cylinder lock for front lid of PW250 housing incl. 2 keys