

VS121 User Guide

AI Workplace Occupancy Sensor
Featuring LoRaWAN®



Safety Precautions

Milesight will not shoulder responsibility for any loss or damage resulting from not following the instructions of this operating guide.

- ❖ The device must not be disassembled or remodeled in any way.
- ❖ To avoid risk of fire and electric shock, do keep the product away from rain and moisture before installation.
- ❖ Do not place the device where the temperature is below/above the operating range.
- ❖ Do not touch components which may be hot.
- ❖ The device must never be subjected to shocks or impacts.
- ❖ Make sure the device is firmly fixed when installing.
- ❖ Make sure the plug is firmly inserted into the power socket.
- ❖ Do not expose the device to where a laser beam equipment is used.
- ❖ Use a soft, dry cloth to clean the lens of the device. Stubborn stains can be removed using a cloth dampened with a small quantity of detergent solution, then wipe them dry.

Declaration of Conformity

VS121 is in conformity with the essential requirements and other relevant provisions of the CE, FCC, and RoHS.

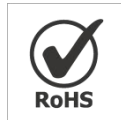

Copyright © 2011-2024 Milesight. All rights reserved.

All information in this guide is protected by copyright law. Whereby, no organization or individual shall copy or reproduce the whole or part of this user guide by any means without written authorization from Xiamen Milesight IoT Co., Ltd.

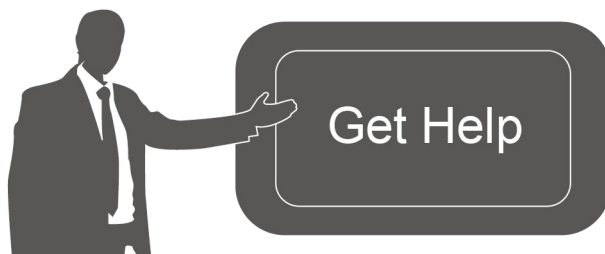

For assistance, please contact

Milesight technical support:

Email: iot.support@milesight.com

Support Portal: support.milesight-iot.com

Tel: 86-592-5085280

Fax: 86-592-5023065

Address: Building C09, Software Park
Phase III, Xiamen 361024,
China

Revision History

Date	Doc Version	Description
Apr. 26, 2021	V 1.0	Initial version
Jan. 18, 2022	V 1.1	<ol style="list-style-type: none"> 1. Support line crossing counting feature; 2. Support D2D feature; 3. Support people counting debounce; 4. Support uploading max number of people; 5. Support downlink control.
Apr. 8, 2022	V 1.2	<ol style="list-style-type: none"> 1. Milesight LOGO update; 2. Support recognition scheme selection.
June 20, 2022	V 1.3	<ol style="list-style-type: none"> 1. Update web GUI menu; 2. Support customize people counting detection area to 16 regions; 3. Add recommended installation guide and line drawing note.
Dec. 14, 2022	V 1.4	<ol style="list-style-type: none"> 1. Support per region people counting uplinks 2. Add private mask feature 3. Add LoRaWAN single channel mode 4. Add Wi-Fi SSID broadcast option 5. Delete Auto Reboot and LoRaWAN V1.1.0 option 6. Support live view blur process and delete Image Config
Mar. 9, 2023	V1.5	<ol style="list-style-type: none"> 1. Add privacy mode under activation page 2. Support filter U-turns feature
Apr. 20, 2023	V1.6	Add installation height of high ceiling mount version
July 15, 2023	V1.7	<ol style="list-style-type: none"> 1. Add people flow analysis feature; 2. Reporting interval range is extended to 5~86400s; 3. Add report interval downlink control command; 4. Add rejoin 9~16 people uplink definition. 5. Adjust illuminance of region people counting.
Apr. 8, 2024	V1.8	<ol style="list-style-type: none"> 1. Support region dwell time detection; 2. Support to report data with timestamp; 3. Support data retransmission feature; 4. Support time sync with Milesight gateway.

Contents

1. Product Introduction	5
1.1 Overview	5
1.2 Key Features	5
2. Hardware Introduction	5
2.1 Packing List	5
2.2 Hardware Overview	6
2.3 Buttons and LED Indicators	6
2.4 Dimensions (mm)	6
3. Access the Sensor	7
3.1 Access without Plugin	7
3.2 Access with Plugin	8
4. Operation Guide	10
4.1 Live Video	10
4.2 People Counting	11
4.2.1 Region People Counting	11
4.2.2 Line Crossing Counting	13
4.2.3 People Flow Analysis	15
4.2.4 LoRaWAN® & Milesight D2D	16
4.2.5 Wi-Fi	19
4.2.6 General Settings	21
4.2.7 Privacy Mask	22
4.3 System	22
4.3.1 User	22
4.3.2 Security Service	24
4.3.3 System Info	24
4.3.4 Date & Time	24
4.3.5 System Maintenance	25
4.3.6 About	26
5. Mount the Sensor	27
5.1 Recommended Height for Certain Object	27
5.2 Illuminance Requirements for AI Analysis	27
5.3 Recommended Installation for Line Crossing Counting	28
5.4 Factors Affecting Accuracy	29
5.5 Ceiling Installation	29
6. Communication Protocol	30
6.1 Uplink Data	30
6.2 Downlink Command	33

1. Product Introduction

1.1 Overview

VS121, based on Artificial Intelligence (AI) technology, is an AI workplace sensor designed to monitor occupancy & utilization in modern workspace, which can reach up to 98% recognition rate. Only counter values are transmitted over LoRaWAN® network to prevent privacy concerns. VS121 to prevent the privacy concerns. VS121 is equipped with Wi-Fi for easy configuration without any tools.

Sensor data are transmitted in real-time using standard LoRaWAN® protocol. LoRaWAN® enables encrypted radio transmissions over long distance while consuming very little power. The user can obtain sensor data and view the trend of data change through the user's own network server.

1.2 Key Features

- Recognition rate is up to 98% based on advanced AI identification and analysis technology and wide detection range
- Support people counting, occupancy detection and dwell time detection
- Support to map up to 16 custom regions
- Allow for bi-direction line crossing people counting
- Support U-turn detection for effective data and precise detection
- Support people flow analysis to calculate the traffic from different directions
- No image data is collected, free from privacy concerns
- Equipped with Wi-Fi for web GUI configuration
- Function well with standard LoRaWAN® gateways and network servers

2. Hardware Introduction

2.1 Packing List

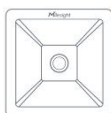

1 x VS121 Device



4 x Wall Mounting
Kits



1 x
Type-C Cable (1 m) &
Power Adapter

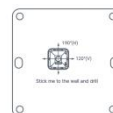

1 x
Mounting Sticker

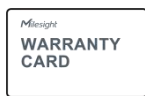

1 ×

Warranty Card



1 ×

Quick Guide

! If any of the above items is missing or damaged, please contact your sales representative.

2.2 Hardware Overview

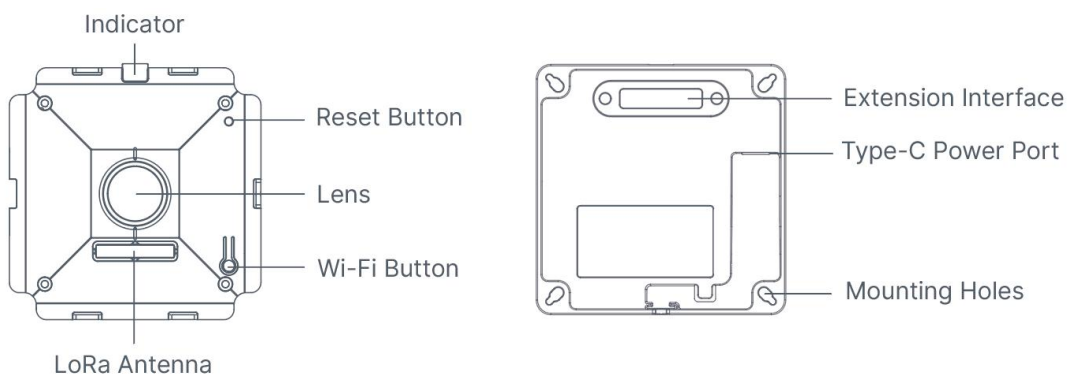

2.3 Buttons and LED Indicators

Function	Action	LED Indication
Turn On/Off Wi-Fi	Press and hold the Wi-Fi button for more than 3 seconds.	Off → On
	Press and hold the Wi-Fi button for more than 3 seconds.	On → Off
Reset to Factory Default	Press and hold the reset button for more than 10 seconds.	Blinks 6 times.

2.4 Dimensions (mm)

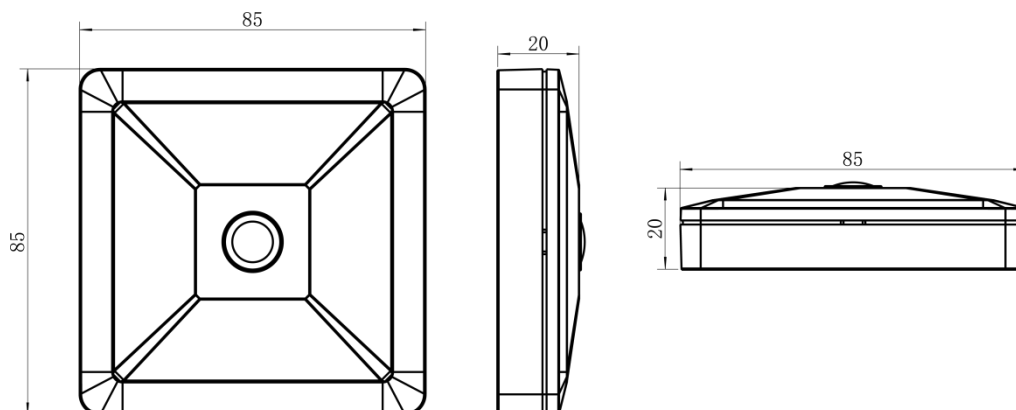

3. Access the Sensor

VS121 sensor provides user-friendly web GUI for configuration and users can access it via Wi-Fi connection. The recommended browsers are Internet Explorer, Firefox, Chrome, Microsoft Edge, Safari. The default IP of sensor is 192.168.1.1, and default SSID is Workplace Sensor_XXXXXX (can be found on the label).

3.1 Access without Plugin

Step 1: Power on the device.

Step 2: Enable the Wireless Network Connection on your computer and search for corresponding access point, then connect computer to this access point.

Step 3: Open the Browser and type 192.168.1.1 to access the web GUI.

Step 4: Select the language.

Step 5: Users need to set the password and privacy mode when using the sensor for the first time. And three security questions can also be set optionally. After configuration, use username (admin) and custom password to log in the sensor.

Note:

- 1) Password must be 8 to 32 characters long, containing at least one number and one letter.
- 2) You can click the "forgot password" in login page to reset the password by answering three security questions when you forget the password, if you set the security questions in advance.
- 3) If you need to reset the privacy mode, hold on reset button for 10s to reset device to factory default.

Language English

Activation

admin

NEXT

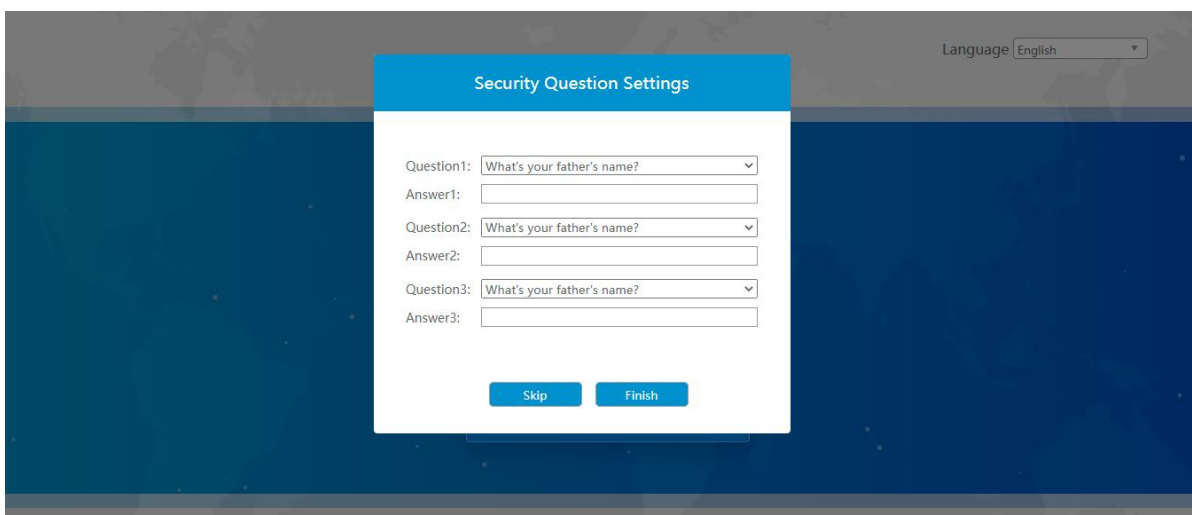
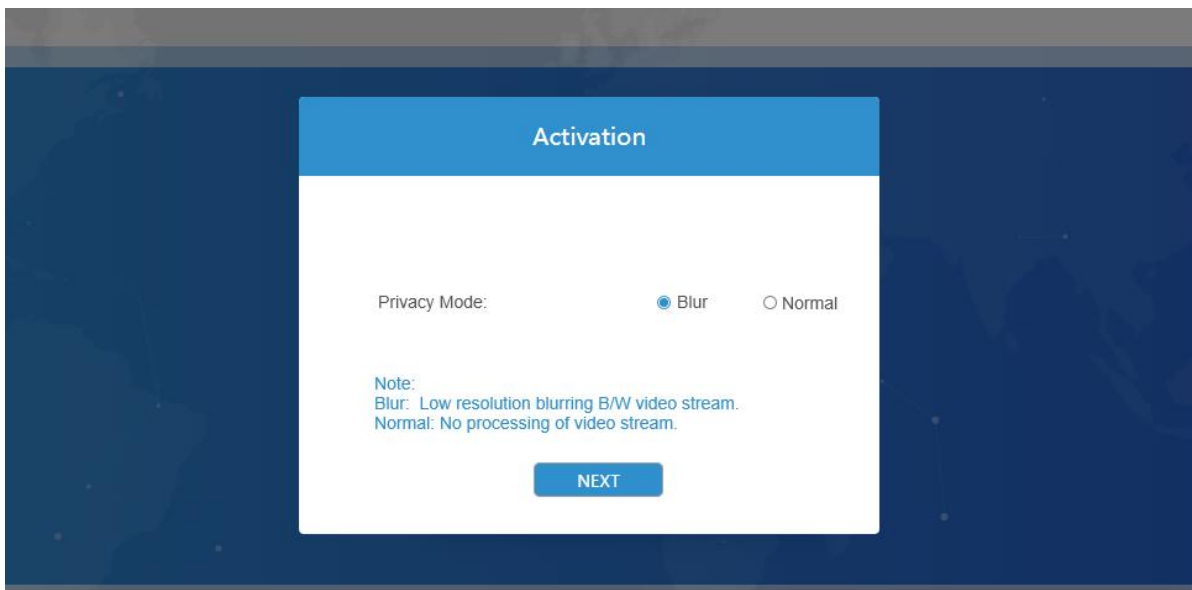

3.2 Access with Plugin

For IE browser access, users need to install the MsActiveX firstly. You can refer the steps as follows:

Step1: Launch the IE browser and enter the IP address of the sensor;

Step2: Enter the user name and custom password and click "Login";

Step3: At the first time to log in the device, the browser will prompt to install Controls, please click "Click here to download and install controls manually" as shown below;

Click here to download and install controls manually

Note: During installing the controls, please keep the browsers close.

Step4: Follow the prompts to install the Controls, when it's finished, it will pop out a window as shown below. Please click "Finish" and refresh the browser, then you will see the video.

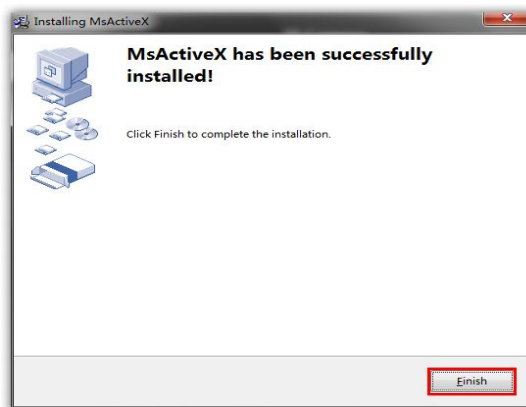

If IE9 or higher version browser is used, it is suggested that the web link should be added as a trusted site. See the instructions as follows:

Step1: Start the IE9 or higher version browser, and select "Tools"→ "Internet Options";

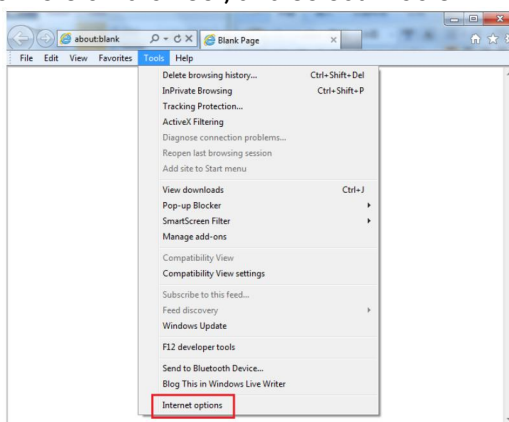

Step2: Select "Security" to "Trusted";

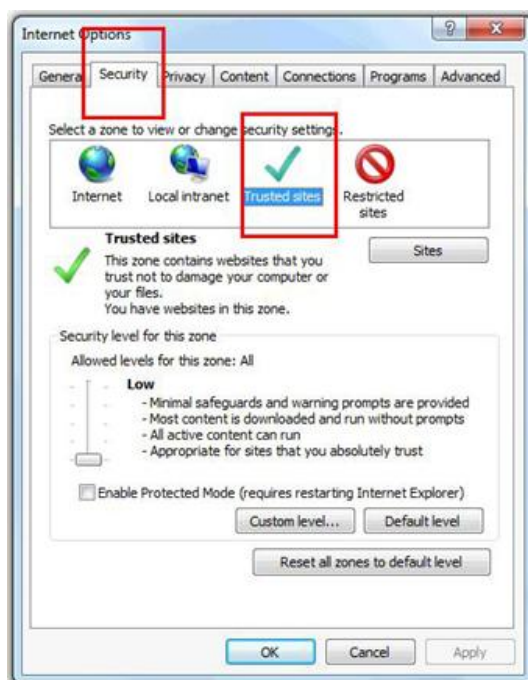

Step3: Enter the IP address of the device in the blank and click "Add";

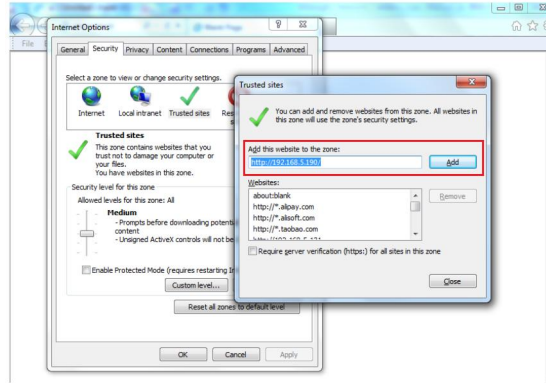

Step4: Enter the IP address. After logging on web GUI successfully, user is allowed to view live video.

4. Operation Guide

4.1 Live Video

After logging on to the device web GUI successfully, user is allowed to view live video as follows.



Parameters	Description
 Configuration	Click to access the configuration page
People Counting (Region) ▾	<p>People Counting (Region): show the mapped or non-mapped regions of people counting</p> <p>Line Crossing Counting: show the detection line and counting people it detected</p> <p>People Flow Analysis: show the detection area and people it detected</p>

4.2 People Counting

4.2.1 Region People Counting

Users can set the report settings and detection regions here.

Enable:	<input checked="" type="checkbox"/>
Number of People:	0
Dwell Time Detection:	<input checked="" type="checkbox"/>
Min. Dwell Time(s):	<input type="text" value="5"/>
Settings	
Report With Timestamp:	<input type="checkbox"/>
Report Regularly:	<input checked="" type="checkbox"/>
Periodic Report Scheme:	<input type="text" value="From Now On"/>
Reporting Interval(s):	<input type="text" value="300"/>
Report by Result:	<input checked="" type="checkbox"/>
Mode:	<input type="text" value="Zero⇌Non-zero"/>
Debounce Time:	<input checked="" type="checkbox"/>
Reset Cumulative Count on Schedule:	<input type="checkbox"/>
Time of Reset:	<input type="text" value="Everyday"/> <input type="text" value="00"/> <input type="text" value="00"/>

Parameters	Description
Enable	Enable or disable region people counting feature.
Number of People	Show current number of people.
Dwell Time Detection	Enable or disable dwell time detection of objects within the area.
Min. Dwell Time(s)	Filter the count below this dwell time.
Report with Timestamp	Report the data with timestamp.
Report Regularly	Select the periodic report of "On the Dot" or "From Now On".
Periodic Report Scheme	On the Dot: The device will report at the top of each hour. For example, When the interval is set to 1 hour, it will report at 0:00, 1:00, 2:00 and so on; when the interval is set to 10 minutes, it will report at 0:10, 0:20, 0:30, and so on.
Reporting Interval	From Now On: Begin reporting from this moment onwards and regularly report based on the interval cycle.
Report by Result	Report according to the following changes of people number result: <ul style="list-style-type: none"> ● Zero to Non-zero/Non-zero to Zero ● Once result changes

Debounce Time	VS121 will reduce the count value only when the people come out of the detection area for more than 2 s.
Reset Cumulative Count on Schedule	Enable to periodically reset cumulative count on schedule. Cumulative Count includes: Total In/Out counting of each detection region. Max./Avg. Dwell Time of each detection region.

Set Detection Region

Enable:

Detection Area: Mapped Region

Reporting Type: Region People Counting

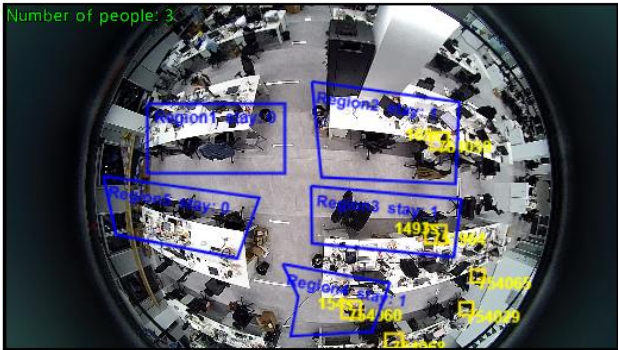

Clear All
Delete

Parameters	Description
Enable	Enable the detection area customization feature. If disabled, the whole area will be the detection area.
Detection Area	Select the customized area as either mapped or except mapped area. You can draw the area in the below screen. 16 regions can be set at most. Mapped Region: Only people who are in the mapped region will be detected. Non-mapped Region: Only people who are not in the mapped region will be detected. Note: when drawing the area, right click the mouse can make the area closed.
Reporting Type	When detection area is in Mapped Region type, users can select two reporting types: Occupancy: report the occupancy status of per mapped region. Region People Counting: report the specific number of people of per mapped region.
	Zoom up the live view to draw the areas.
Clear All	Clear all areas you have drawn before.
Delete	Select the area and click Delete to delete this area.

4.2.2 Line Crossing Counting

The sensor will count the number of people who crossed a defined virtual line, then upload the count value according to the reporting interval.

Enable:	<input type="checkbox"/>
Report With Timestamp:	<input type="checkbox"/>
Periodic Report Scheme:	From Now On <input type="button" value="v"/>
Reporting Interval(s):	300 <input type="button" value="v"/>
Filter U-turns:	<input checked="" type="checkbox"/>
Reset Cumulative Count on Schedule:	<input type="checkbox"/>
Time of Reset:	Everyday <input type="button" value="v"/> 00 <input type="button" value="v"/> 00 <input type="button" value="v"/>

Set Detection Line

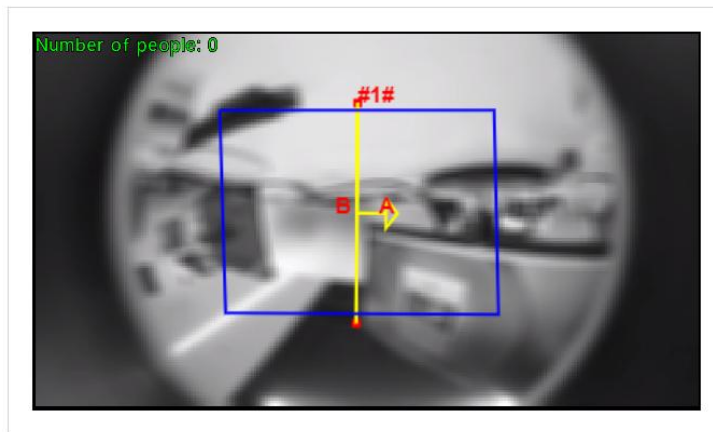

Draw Area Draw Line

Clear Area

Parameters	Description
Enable	Enable or disable line crossing counting feature.
Report with Timestamp	Report the data with timestamp.
Periodic Report Scheme	Select the periodic report of "On the Dot" or "From Now On".
Reporting Interval	On the Dot: The device will report at the top of each hour. For example, When the interval is set to 1 hour, it will report at 0:00, 1:00, 2:00 and so on; when the interval is set to 10 minutes, it will report at 0:10, 0:20, 0:30, and so on. From Now On: Begin reporting from this moment onwards and regularly report based on the interval cycle.
Filter U-turns	When enabled, it allows to draw an area and the device will count the in and out values only when people cross along this area.
Reset Cumulative Count on	Enable to periodically reset cumulative line cross counting values on schedule.

Schedule	
Set Detection Line	The device allows to set up only one line with at most 4 segments. For the detection line, crossing along the direction of the arrow means "In" and the opposite is "Out". When drawing, left-click to start drawing and drag the mouse to draw a line, left-click again to continue drawing the other segment and right-click the mouse to complete the drawing.
	Zoom up the live view to draw the line or area.
Clear Line	Clear the line you have drawn before.
Clear Area	Clear the area you have drawn before.

Note:

1) The arrow direction of the detection line depends on your drawing direction.

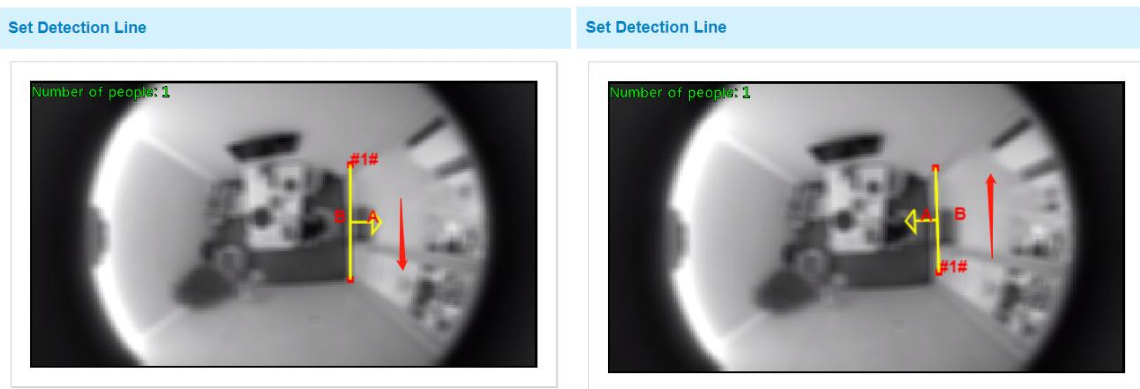

2) Ensure that the detected targets can pass through the detection line completely. It's recommended that the detection line is perpendicular to the In/Out direction and on the center of detection area without other objects around.

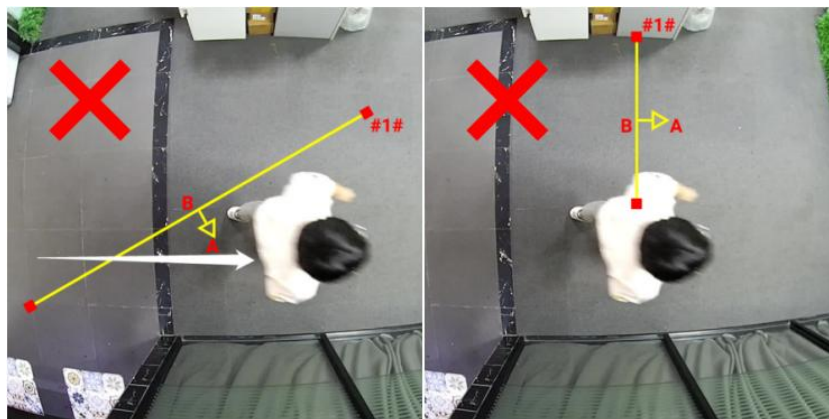

3) A redundant identification area needed to be left on both sides of the detection line for the target. This is to ensure that the sensor has stable recognition and tracking of this target before it passes the detection line, which will make the detection and count more accurate.

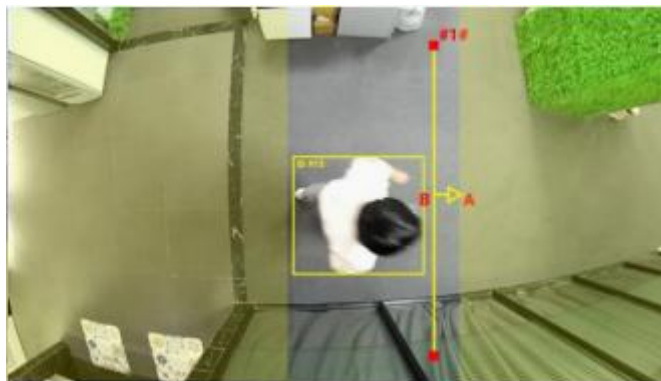

4.2.3 People Flow Analysis

The sensor will count the number of people cross different directions, then upload the counting data according to the reporting interval.

Enable:	<input type="checkbox"/>
Report With Timestamp:	<input type="checkbox"/>
Periodic Report Scheme:	From Now On ▼
Reporting Interval(s):	300

Parameters	Description
Enable	Enable or disable people flow analysis feature.
Report with Timestamp	Report the data with timestamp.
Periodic Report Scheme	Select the periodic report of "On the Dot" or "From Now On". On the Dot: The device will report at the top of each hour. For example, When the interval is set to 1 hour, it will report at 0:00, 1:00, 2:00 and so on; when the interval is set to 10 minutes, it will report at 0:10, 0:20, 0:30, and so on.
Report Interval	From Now On: Begin reporting from this moment onwards and regularly report based on the interval cycle.

Set Detection Region



Parameters	Description
Set Detection Region	Customize a triangle or a convex quadrangle to count the people flow from one edge to another edge.
	Zoom up the live view to draw the areas.
Clear	Clear the area you have drawn before.

4.2.4 LoRaWAN® & Milesight D2D

LoRaWAN

LoRaWAN settings is used for configuring the transmission parameters in LoRaWAN® network.

Status:	Activated
Basic Settings	
Device EUI:	24E124600C316312
App EUI:	<input type="text" value="24E124C0002A0001"/>
Join Type:	<input type="text" value="OTAA"/>
Application Key:	<input type="text" value="*****"/>
RX2 Data Rate	<input type="text" value="DR0 (SF12, 125k)"/>
RX2 Frequency/MHz	<input type="text" value="505.3"/>
Advanced Settings	
Confirmed Mode:	<input type="checkbox"/>
ADR:	<input checked="" type="checkbox"/>
Rejoin Mode:	<input checked="" type="checkbox"/>
LinkCheckReq Message Retries:	<input type="text" value="8"/>
Port:	<input type="text" value="85"/>
Spreading Factor:	<input type="text" value="SF10-DR2"/>
LoRaWAN Version:	<input type="text" value="V1.0.3"/>

Parameters	Description
Status	LoRaWAN® network status of this device.
Basic Settings	
Device EUI	Unique ID of the device which can also be found on the label.
App EUI	Default App EUI is 24E124C0002A0001.
Join Type	OTAA and ABP mode are available.
Application Key	Appkey for OTAA mode, default is 5572404C696E6B4C6F52613230313823.
Device Address	DevAddr for ABP mode, default is the 5 th to 12 th digits of SN.
Network Session Key	Nwkskey for ABP mode, default is 5572404C696E6B4C6F52613230313823.
Application Session Key	Appskey for ABP mode, default is 5572404C696E6B4C6F52613230313823.
RX2 Data Rate	RX2 data rate to receive downlinks or send D2D command.
RX2 Frequency/MHz	RX2 frequency to receive downlinks or send D2D command.
Advanced Settings	

Confirmed Mode	If the device does not receive ACK packet from network server, it will resend data once.
ADR Mode	Allow network server to adjust data rate of the device.
Rejoin Mode	The device will send a specific number of LinkCheckReq MAC packets to the network server every 30 mins to validate connectivity; If there is no response, the device will re-join the network.
Application Port	The port used for sending and receiving data, default port is 85.
Spreading Factor	If ADR is disabled, the device will send data via this spreading factor.
LoRaWAN® Version	V1.0.2 and V1.0.3 are available.
Region	Frequency plan of this device.
Single-channel Mode	When enabled, only one channel can be selected to send uplinks. Please enable this mode if you connect device to DS7610.
Channel	Enter the index to select the frequency channel. Examples: 1, 40: Enabling Channel 1 and Channel 40 1-40: Enabling Channel 1 to Channel 40 1-40, 60: Enabling Channel 1 to Channel 40 and Channel 60 All: Enabling all channels Null: Indicates that all channels are disabled

Note:

- 1) Please contact sales for device EUI list if there are many units.
- 2) Please contact sales if you need random App keys before purchasing.
- 3) Select OTAA mode if you use Milesight IoT cloud to manage devices.
- 4) Only OTAA mode supports rejoin mode.

Milesight D2D

Milesight D2D protocol is used for setting up transmission among Milesight LoRaWAN® devices without gateway. When the Milesight D2D setting is enabled, VS121 can work as a Milesight D2D controller for sending control commands to trigger D2D agent devices.

D2D Settings	
Enable D2D	<input checked="" type="checkbox"/>
D2D Key	*****
Control Settings	
Condition 1	Occupied
Control Command 1	0000
Condition 2	Vacant
Control Command 2	0000
Intelligent Delay Time (s)	60 ⓘ

Parameters	Description
Enable D2D	Enable or disable D2D feature.
D2D Key	Define a unique D2D key and this key is the same as the setting in D2D agent device. Default value: 5572404C696E6B4C6F52613230313823
Condition	Occupied: when total people counter value is non-zero in detection area Vacant: when total people counter value is 0 in detection area
Control Command	Define a 2-byte hexadecimal control command (0x0000 to 0xffff). When the condition is meet, the device will send the control command to corresponding D2D agent devices.
Intelligent Delay Time (s)	The device will send the control command only when the detected condition remains Vacant (number of people =0) during this delay time.

Note: When this feature is enabled, the control command from this device will not send to LoRaWAN® gateway.

4.2.5 Wi-Fi

Enable:	<input checked="" type="checkbox"/>
Work Mode:	AP
SSID:	<input type="text" value="Workplace Sensor_F5BA09"/>
SSID Broadcast:	<input checked="" type="checkbox"/>
Protocol:	<input type="text" value="802.11n (2.4G)"/>
Bandwidth:	<input type="text" value="20MHz"/>
Channel:	<input type="text" value="auto"/>
Security Mode:	<input type="text" value="No Encryption"/>
DHCP Server Settings:	
LAN IP Address:	<input type="text" value="192.168.1.1"/>
Netmask:	<input type="text" value="255.255.255.0"/>
Start Address:	<input type="text" value="192.168.1.100"/>
End Address:	<input type="text" value="192.168.1.199"/>
Lease Time (min):	<input type="text" value="1440"/>
Primary DNS Server:	<input type="text" value="114.114.114.114"/>
Secondary DNS Server:	<input type="text" value="8.8.8.8"/>
Static IP	
MAC Address	IP Address
<input type="text"/>	<input type="text"/> <input type="button" value="x"/>

Parameters	Description
Enabled	Enable Wi-Fi feature.
Work Mode	Work mode is fixed as AP and can not connect to other access point.
SSID	The unique name for this device Wi-Fi access point.
SSID Broadcast	When disabled, other wireless devices can't find the SSID, and users should enter the SSID manually to get access to the wireless network.
Protocol	802.11b (2.4 GHz), 802.11g (2.4 GHz), 802.11n (2.4 GHz) are optional.
Bandwidth	20 MHz or 40 MHz are optional.
Channel	Select the wireless channel. Auto, 1,...11 are optional.
Security Mode	No Encryption, WEP Open System, WEP Shared Key, WPA-PSK, WPA2-PSK and WPA-PSK/WPA2-PSK are optional.
DHCP Server	LAN IP Address: IP address that used to access the web GUI of sensor.
Settings	Subnet mask: identify the subnet where the sensor is located.

	<p>Start Address: define the beginning of IP address pool which assigns to DHCP clients.</p> <p>End Address: define the end of IP address pool which assigns to DHCP clients.</p> <p>Lease Time (min): the lease time on which DHCP client can use the IP address assigned by the sensor.</p> <p>Primary DNS Server: translate the domain name to IP address.</p> <p>Secondary DNS Server: backup DNS server.</p>
Static IP Settings	Add MAC address and static IP address if users need to add a static IP address to a specific computer.

4.2.6 General Settings

Data Retransmission Setting

Data Retransmission:

Algorithm

Recognition Scheme: Algorithm 2 ⓘ

Image

Power Line Frequency: 50Hz ▼

Wide Dynamic Range: Off ▼

Parameters	Description
Data Retransmission Setting	Enable to resend stored data packets from the disconnected period when the device's network connection is restored. The device supports to store 3,000 pieces of data at most. The historical data format is different from regular reports.
Recognition Scheme	<p>Select the recognition scheme of region people counting based on your detection environment.</p> <p>Algorithm 1: Suitable for monitoring complex environments which have many objects, like office supplies (books, printers, lamps, etc.)</p> <p>Algorithm 2: Suitable for monitoring simple and clean environments like meeting rooms.</p>
Image	<p>Power Line Frequency: Select based on your power source frequency standard, 60 Hz and 50 Hz are available.</p> <p>Wide Dynamic Range: This function which can capture and display both bright and dark areas in the same frame that enables details of objects in both bright and dark areas to be visible. It's recommended to enable this function when the scene has a clear contrast between light and dark (such as a corridor).</p>

4.2.7 Privacy Mask

Privacy mask enables to cover certain areas on the live video to prevent certain spots in the surveillance area from being viewed and prevent people within the area from being counted. You can set 8 mask areas at most.

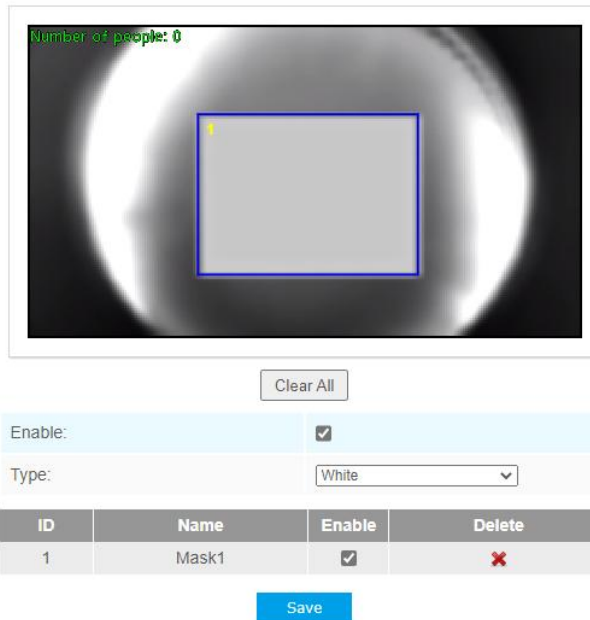

Note: Support up to 8 Privacy Mask areas.

Parameters	Description
Enable	Check the checkbox to enable the Privacy Mask function.
Clear All	Clear all areas you drew before.
Type	Select the color for the privacy areas, there are two colors available: White and Black

4.3 System

4.3.1 User

Security Question

Security Question: Edit

Account Management

Admin Password:

User Level: Administrator ▼

User Name:

New Password:

Confirm:

Save

Parameters	Description
Security Question	<p>Click Edit button to set three security questions for your device. In case that you forget the password, you can click Forget Password button on login page to reset the password by answering three security questions correctly.</p> <div style="border: 1px solid #ccc; padding: 10px; margin: 10px auto; width: 80%; text-align: center;"> <p style="color: #00796b; margin: 0;">Security Question Settings</p> <p>Admin Password: <input style="width: 150px;" type="text"/></p> <p>Security Question1: What's your father's name? ▼</p> <p>Answer1: <input style="width: 150px;" type="text"/></p> <p>Security Question2: What's your father's name? ▼</p> <p>Answer2: <input style="width: 150px;" type="text"/></p> <p>Security Question3: What's your father's name? ▼</p> <p>Answer3: <input style="width: 150px;" type="text"/></p> <p style="text-align: center; margin-top: 10px;">Save</p> </div> <p>There are twelve default questions below, you can also customize the security questions.</p> <div style="border: 1px solid #ccc; padding: 5px; margin: 10px auto; width: 80%;"> <p style="background-color: #00796b; color: white; padding: 2px;">What's your father's name?</p> <p>What's your favorite sport?</p> <p>What's your mother's name?</p> <p>What's your mobile number?</p> <p>What's your first pet's name?</p> <p>What's your favorite book?</p> <p>What's your favorite game?</p> <p>What's your favorite food?</p> <p>What's your lucky number?</p> <p>What's your favorite color?</p> <p>What's your best friend's name?</p> <p>Where did you go on your first trip?</p> <p>Customized Question</p> </div>
Account	<p>Admin Password: enter the correct admin password before adding an account.</p>

Management	<p>User Level: It's fixed as Administrator.</p> <p>User Name: It's fixed as admin.</p> <p>New Password: Input password for the account.</p> <p>Confirm: Confirm the password.</p>
------------	---

4.3.2 Security Service

SSH Settings

Enable SSH:

SSH Port:

[Save](#)

Parameters	Description
Enable SSH	Enable SSH feature.
SSH Port	Set the port to access this sensor via SSH.

4.3.3 System Info

All information about the hardware and software can be checked on this page.

System	
Device Name:	<input type="text" value="Workplace Sensor"/>
Product Model:	VS121-915M
SN:	6600B5053760
Hardware Version:	V1.3
Software Version:	31.7.0.78-iot2
MAC Address:	24:E1:24:F3:C5:B2

4.3.4 Date & Time

Here you can check and set the system time.

Current System Time	
Date:	07/04/2024
Time:	20:29:21
Set the System Time	
Time Zone:	(UTC-08:00) United States - Paci
Daylight Saving Time:	Automatic
<input type="radio"/> Synchronize With Gateway Time	
<input type="radio"/> Manual	
Time:	07/04/2024 20:29:19
<input checked="" type="radio"/> Synchronize with computer time	
Date:	07/04/2024
Time:	20:29:22

Parameters	Description
Current System Time	Current date & time of the system.
Time Zone	Select a time zone according to your location.
Daylight Saving Time	Enable or disable the daylight saving time.
Synchronize with Gateway time	Synchronize the system time with embedded network server of Milesight gateway when LoRaWAN® version is 1.0.3. The device will sync the time with gateway once when re-joining the network or every 5 days.
Manual	Set the system time manually.
Synchronize with computer time	Synchronize the system time with the computer.

4.3.5 System Maintenance

System Upgrade

Software Version:	31.7.0.78-iot2
Local Upgrade:	<div style="display: flex; align-items: center; gap: 10px;"> <input type="button" value="Choose File"/> No file chosen </div> <div style="display: flex; align-items: center; gap: 10px;"> <input type="button" value="Upgrade"/> <input type="checkbox"/> Reset after Upgrading </div>

Note: Do not disconnect the power of the device during the upgrade.

Maintenance

Reset <input checked="" type="checkbox"/> Keep the User Information	<input type="button" value="Reset"/>
Export Config File:	<input type="button" value="Export"/>
Config File:	<div style="display: flex; align-items: center; gap: 10px;"> <input type="button" value="Choose File"/> No file chosen </div>
Import Config File:	<input type="button" value="Import"/>

Reboot

Reboot the Device:	<input type="button" value="Reboot"/>
--------------------	---------------------------------------

Parameters	Description
System Upgrade	<p>Software Version: The software version of the sensor.</p> <p>Local Upgrade: Click the Choose File button and select the upgrading file, then click the Upgrade button to upgrade. After the system reboots successfully, the update is done.</p> <p>You can check Reset after Upgrading to reset the device after upgrading it.</p> <p>Note: Do not disconnect the power of the device during the upgrade process. The device will be restarted to complete the upgrading.</p>
Maintenance	<p>Reset settings: Click Reset button to reset the device to factory default settings</p> <p>Keep the User Information: Check this option to keep the user information when resetting</p> <p>Export Config File: Export configuration file.</p> <p>Import Config File: Click the Choose File button and select the configuration file, click Import button to import configuration file.</p>
Reboot	Restart the device immediately

4.3.6 About

User can view some open source software licenses about the sensor by clicking the View Licenses button.

Open Source Software Licenses

[View Licenses](#)

5. Mount the Sensor

To better utilize the advantages of AI algorithm, there are some important steps to follow :

5.1 Recommended Height for Certain Object

Object	Height	Note
sitting object	>2.5m (8.2ft)	Commonly used for Region People Counting
standing object	>3m (9.8ft) (the optimum height is 3m)	Commonly used for Line Crossing Counting and People Flow Analysis

Recommended detection ranges for region people counting and people flow analysis at different heights:

Version	Height	Recommended detection range
Standard Version	2.3m	2.6m*8.6m
	2.5m	3.2m*9.8m
	2.7m	4.2m*13.6m
	3m	4.8m*14m
	3.2m	5.2m*15.4m
	3.5m	6m*17m
	4m	6.8m*18.8m
High Ceiling Mount Version	5m	3.5m*10m
	6m	4.5m*12m
	7m	5.5m*14m

5.2 Illuminance Requirements for AI Analysis

- ❖ Region People Counting
 - We recommend that the illuminance is greater than 20Lux.
 - We recommend enabling [WDR function](#), which will make the image effect better.
- ❖ Line Crossing Counting and People Flow Analysis
 - We recommend that the illuminance is greater than 50Lux.
 - When the illuminance is between 20~50Lux, we recommend disabling WDR function.
 - When the illuminance is >50Lux and the scene has a clear contrast between light and dark (such as a corridor), we recommend enabling WDR function.

To know the illuminance of the current scene, you must use an illuminance meter, or you can refer to the following common environmental illuminance values:

place/environment	illuminance
Indoors at dusk	10Lux
cloudy indoor	5~50Lux
sunny indoor	100~1000Lux

5.3 Recommended Installation for Line Crossing Counting

- Make sure the sensor is facing straight down, in line with the ceiling.

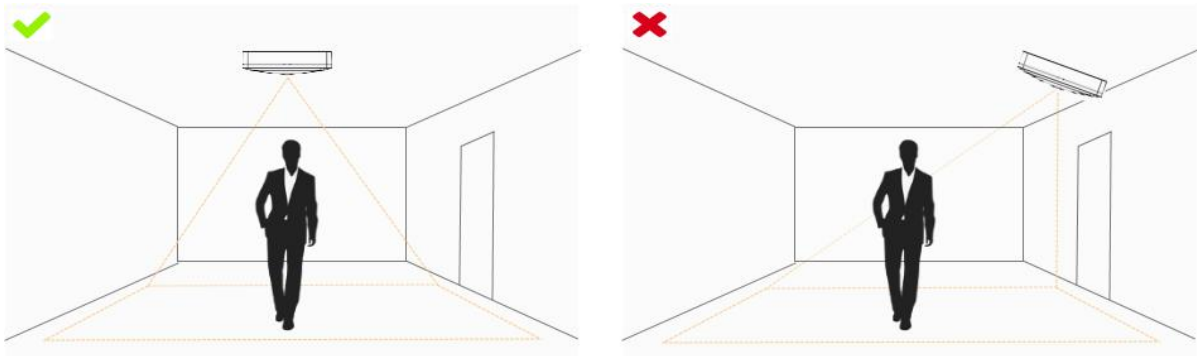

- Make sure there is sufficient white light on site.

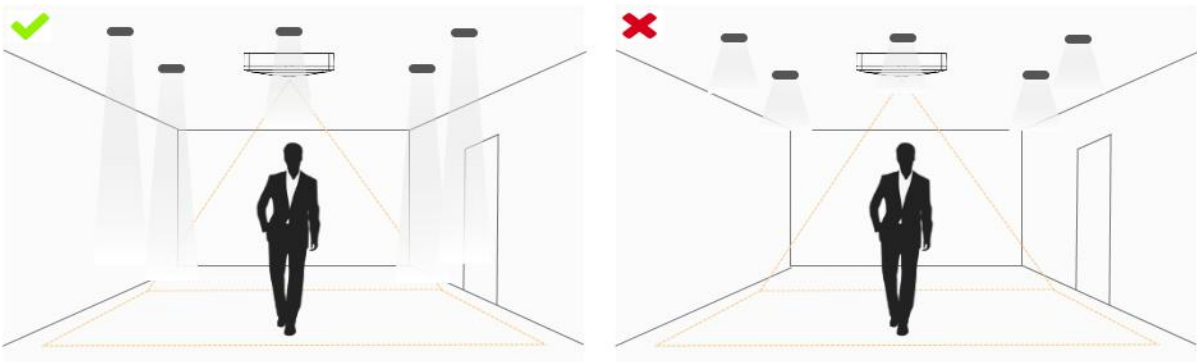

- Avoid getting very strong light, like sunlight.

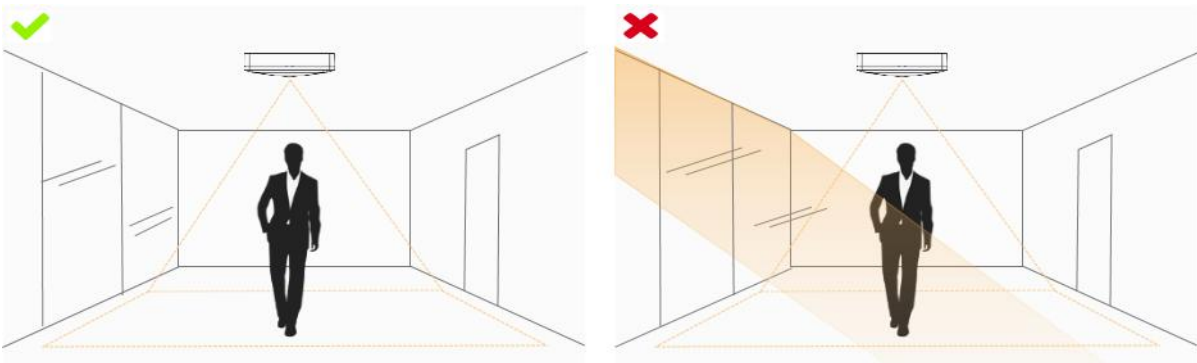

- Make sure there are no moving objects interfering in the counting area. For example, do not install the sensor too close to a door.

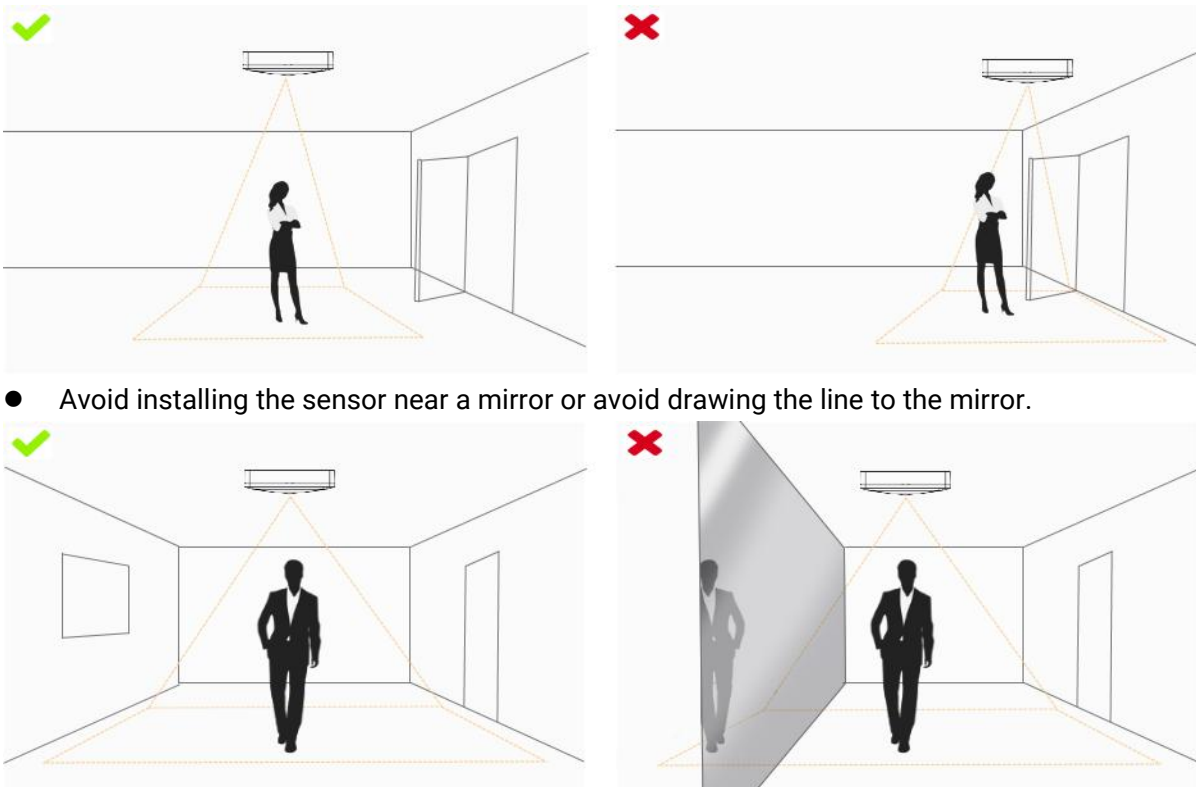

- Avoid installing the sensor near a mirror or avoid drawing the line to the mirror.

5.4 Factors Affecting Accuracy

- The color of hair or clothes is close to the floor color.

Reason: It will make it difficult for the algorithm to identify the correct object, thus affecting the accuracy.

- The floor color and wall color are black.

Reason: The brightness of the scene will be reduced due to the absorption of light by black.

- The contrast between light and dark in the scene is too strong.

Reason: It will cause the people to be backlight, which will affect the accuracy of the detection.

5.5 Ceiling Installation

Step 1: Ensure the thickness of ceiling is more than 30 mm, then attach the mounting sticker to the ceiling and drill 4 holes with a diameter of 6 mm.

Step 2: Fix the wall plugs into the ceiling holes.

Step 3: Remove the cover on the device, then fix the device to the wall plugs via mounting screws; remember to adjust the mounting direction according to the detection area requirement and direction sticker on the inner cover.

Step 4: Take the cover back to device; note that the Milesight Logo should be facing the LED indicator.

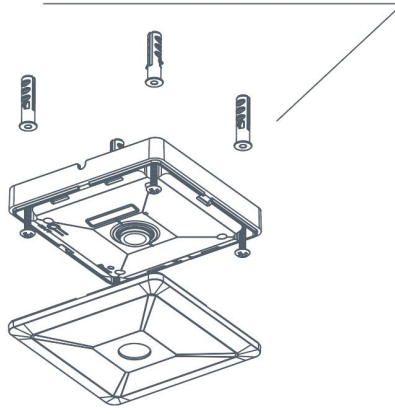

6. Communication Protocol

VS121 reports basic information only when joining the network and reports people counter according to reporting settings. All data are based on following format(HEX):

Channel1	Type1	Data1	Channel2	Type2	Data2	Channel 3	...
1 Byte	1 Byte	N Bytes	1 Byte	1 Byte	M Bytes	1 Byte	...

For decoder examples please find files on <https://github.com/Milesight-IoT/SensorDecoders>.

6.1 Uplink Data

Item	Channel	Type	Description
Protocol Version	ff	01	01=> V1
Device SN		08	12 digits
Hardware Version		09	01 04 => V1.4
Software Version		1f	1f 07 00 4b => V31.7.0.75
Region People Counter	04	c9	Byte 1: current total number of people Byte 2: the number of mapped regions Byte 3-4: every bit indicates occupancy status of per mapped region, 0=vacant, 1=occupied
Max People Counter	06	cd	1 Byte, maximum number of people in detection area during the reporting interval of region people counting. Note: this value only report on periodic uplinks.
Per Region People Counter	07	d5	8 bytes, region 1 (1B) + region 2 (1B)+... region 8 (1B)
	08		8 bytes, region 9 (1B) + region 10 (1B)+...

			region 16 (1B)	
Dwell Time Detection	0e	e4	Region ID(1B) + Average Dwell Time (2B) + Maximum Dwell Time (2B) Note: region ID=00 means all regions.	
Periodic Line Cross Counter	05	cc	Periodic In (2B)+ Periodic Out (2B)	
Accumulated Line Cross Counter	0d		Accumulated In (2B)+ Accumulated Out (2B)	
People Flow Analysis	09	da	Byte 1-2: number of people from A to A Byte 3-4: number of people from A to B Byte 5-6: number of people from A to C Byte 7-8: number of people from A to D	
	0a		Byte 1-2: number of people from B to A Byte 3-4: number of people from B to B Byte 5-6: number of people from B to C Byte 7-8: number of people from B to D	
	0b		Byte 1-2: number of people from C to A Byte 3-4: number of people from C to B Byte 5-6: number of people from C to C Byte 7-8: number of people from C to D	
	0c		Byte 1-2: number of people from D to A Byte 3-4: number of people from D to B Byte 5-6: number of people from D to C Byte 7-8: number of people from D to D	
Timestamp	0f	85	Unix Timestamp (4B)	
Historical Data	20	ce	Data time stamp (4B) + Data Type (1B) +Historical Data (Mutable)	
			Code	Data Type
			01	Region People Counter
			02	Periodic Line Cross Counter
			03	Max People Counter
			04	Region 1-4 People Counter
			05	Region 5-8 People Counter
06	Region 9-12 People Counter			

			07	Region 13-16 People Counter
			08	People Flow Analysis(A to A, A to B)
			09	People Flow Analysis(A to C, A to D)
			0a	People Flow Analysis(B to A, B to B)
			0b	People Flow Analysis(B to C, B to D)
			0c	People Flow Analysis(C to A, C to B)
			0d	People Flow Analysis(C to C, C to D)
			0e	People Flow Analysis(D to A, D to B)
			0f	People Flow Analysis(D to C, D to D)
			10	Accumulated Line Cross Counter
			11	Dwell Time Detection

Example:

1. Device information: report once whenever joining the network.

ff0101 ff086600b0940976 ff090100 ff1f1f07004b					
Channel	Type	Value	Channel	Type	Value
ff	01 (Protocol Version)	01 (V1)	ff	08 (Device SN)	66 00 b0 94 09 76
Channel	Type	Value	Channel	Type	Value
ff	09 (Hardware version)	0100 (V1.0)	ff	1f (Software version)	1f 07 00 4b (V31.7.0.75)

2. Region people counter periodic report when reporting type is Occupancy

04c9030800a1 06cd05		
Channel	Type	Value
04	c9 (Region People Counter)	Byte 1: 03 => There are 3 people totally currently Byte 2: 08 => there are 8 mapped regions Byte 3-Byte 4: 00 a1=>1010 0001 Region 1, 6 and 8 are occupied, others are vacant
06	cd (Max People Counter)	05 => during the reporting interval, the maximum number of people is 5

3. Region people counter periodic report when reporting type is Region People Counting

07d50001000000000003 06cd05		
Channel	Type	Value
07	d5 (Per Region People Counter)	Byte 2: 01 => there are 1 person in region 2 currently Byte 8: 03 => there are 3 people in region 8 currently

06	cd (Max People Counter)	05 => during the reporting interval, the maximum number of people is 5
----	-------------------------	--

4. Line cross counter periodic report with timestamp:

0f85e8ba1466 05cc02000100 0dcc10000100		
Channel	Type	Value
0f	85 (Timestamp)	e8ba1466 => 6614bae8=1712634600s
05	cc (Line Crossing Counter)	Periodic In: 02 00 => 00 02 = 2 Periodic Out: 01 00 => 00 01 =1
0d	cc (Line Crossing Counter)	Accumulated In: 10 00 => 00 10 = 16 Accumulated Out: 01 00 => 00 01 =1

5. People flow analysis periodic report:

09da0001000000000000 0ada0000000000000000 0bda0000000000000000 0cda0000000000000000		
Channel	Type	Value
09	da (People Flow Analysis)	A to A: 00 01=>01 00=256 A to B: 00 00=0 A to C: 00 00=0 A to D: 00 00=0
0a		B to A: 00 00=0 B to B: 00 00=0 B to C: 00 00=0 B to D: 00 00=0
0b		C to A: 00 00=0 C to B: 00 00=0 C to C: 00 00=0 C to D: 00 00=0
0c		D to A: 00 00=0 D to B: 00 00=0 D to C: 00 00=0 D to D: 00 00=0

6.2 Downlink Command

VS121 supports downlink commands to configure the device. Application port is 85 by default.

Item	Channel	Type	Description
Reboot	ff	10	ff
Reporting Interval		03	2 Bytes, , range: 5~65535, unit: s
Confirmed Mode		04	00: disable, 01: enable
LoRaWAN® Channel Mask		05	Byte 1: Channel index range

		01: 0-15 02: 16-31 03: 32-47 04: 48-63 05: 64-79 06: 80-95 Byte 2-3: indicate disable or enable via every bit, 0=disable, 1=enable
ADR	40	00: disable, 01: enable
Application Port	41	1 Byte, 85 by default
Wi-Fi	42	00: disable, 01: enable
Region People Counting	50	00: disable, 01: enable
Region People Counting Report Regularly	43	00: disable, 01: enable
Region People Counting Report by Result	44	00: disable, 01: enable
Report by Result Mode	45	00: Zero and Non-zero 01: Once result changes
Line Crossing Counting	48	00: disable, 01: enable
Reset Cumulative Count	51	ff

Note: after changing LoRaWAN® setting, the device will re-join the network.

Example:

1. Disable the Wi-Fi.

ff4200		
Channel	Type	Value
ff	42 (Wi-Fi)	00: disable

2. Set AU915 or US915 channel mask as 8-15.

ff0501ff00 ff05020000 ff05030000 ff05040000 ff05050000		
Channel	Type	Value
ff	05 (Channel Mask)	01: Channel index 0-15, ff00 => 8-15 is enabled 02-05: Channel index 16-79, 0000 => all disabled

3. Reboot the device.

ff10ff		
Channel	Type	Value

ff	10 (Reboot)	ff
----	-------------	----

4. Set reporting interval of region counting, line cross counting or people flow analysis as 20 minutes.

ff03b004		
Channel	Type	Value
ff	03 (Reporting Interval)	b0 04 => 04 b0 = 1200s = 20 minutes

-END-