

UG67 User Guide

Outdoor LoRaWAN® Gateway



Preface

Thanks for choosing Milesight UG67 LoRaWAN® gateway. UG67 delivers tenacious connection over network with full-featured design such as automated failover/failback, extended operating temperature, hardware watchdog, VPN, Gigabit Ethernet and beyond.

This guide shows you how to configure and operate the UG67 LoRaWAN® gateway. You can refer to it for detailed functionality and gateway configuration.

Readers

This guide is mainly intended for the following users:

- Network Planners
- On-site technical support and maintenance personnel
- Network administrators responsible for network configuration and maintenance

© 2011-2024 Xiamen Milesight IoT Co., Ltd.

All rights reserved.

All information in this user guide is protected by copyright law. Whereby, no organization or individual shall copy or reproduce the whole or part of this user guide by any means without written authorization from Xiamen Milesight IoT Co., Ltd.

Related Documents

Document	Description
UG67 Datasheet	Datasheet for UG67 LoRaWAN® gateway.
UG67 Quick Start Guide	Quick Installation Guide for UG67 LoRaWAN® gateway.

Declaration of Conformity

UG67 is in conformity with the essential requirements and other relevant provisions of the CE, FCC, and RoHS.





For assistance, please contact
 Milesight technical support:
 Email: iot.support@milesight.com
 Support Portal: support.milesight-iot.com
 Tel: 86-592-5085280
 Fax: 86-592-5023065
 Address: Building C09, Software Park III,
 Xiamen 361024, China

Revision History

Date	Doc Version	Description
Dec. 31, 2020	V1.0	Initial version
Apr. 30, 2021	V1.1	<ol style="list-style-type: none"> 1. Support LoRaWAN® Class B 2. Add Node-RED feature 3. Add Noise-Analyzer feature 4. Add Multicast Groups feature 5. Add application examples
Aug. 24, 2021	V1.2	<ol style="list-style-type: none"> 1. Support Yeastar Workplace platform integration 2. Delete Package Forward status page 3. Phone & Email webpage update
Dec. 15, 2021	V1.3	<ol style="list-style-type: none"> 1. Add AS923-3&AS923-4 2. Change network server channel mask box to channel 3. Add device channel setting in profile
Feb. 23, 2022	V1.4	<ol style="list-style-type: none"> 1. Add batch backup 2. Login webpage update 3. Change default antenna type to external antenna 4. Adjust time of Class C ACK timeout
Jun. 1, 2022	V1.5	<ol style="list-style-type: none"> 1. Support VLAN Trunk client 2. Add System Name in SNMP 3. Add Use L2TP Peer DNS option
Dec.26, 2022	V1.6	<ol style="list-style-type: none"> 1. Add BACnet Server feature 2. Add Payload Codec feature 3. Add Reset and all flows export feature on Node-RED 4. Add data retransmission feature on Packet Forward
March 6, 2023	V1.7	<ol style="list-style-type: none"> 1. Delete embedded antenna mode 2. Add LBT feature
Feb. 21, 2024	V1.8	<ol style="list-style-type: none"> 1. Compatible with Milesight Development Platform 2. Update default secondary ICMP and DNS server address 3. Add cellular IMS and custom MTU feature 4. Add 8 pre-set device profiles

Contents

Chapter 1 Product Introduction	7
1.1 Overview	7
1.2 Advantages	7
1.3 Specifications	8
1.4 Dimensions (mm)	10
Chapter 2 Access to Web GUI	11
2.1 Wireless Access	11
2.2 Wired Access	12
Chapter 3 Web Configuration	14
3.1 Status	14
3.1.1 Overview	14
3.1.2 Cellular (Cellular Version Only)	15
3.1.3 Network	16
3.1.4 WLAN	17
3.1.5 VPN	19
3.1.6 Host List	20
3.2 LoRaWAN	21
3.2.1 Packet Forwarder	21
3.2.1.1 General	21
3.2.1.2 Radios	22
3.2.1.3 Noise Analyzer	24
3.2.1.4 Advanced	25
3.2.1.5 Custom	27
3.2.1.6 Traffic	28
3.2.2 Network Server	29
3.2.2.1 General	29
3.2.2.2 Application	31
3.2.2.3 Payload Codec	34
3.2.2.4 Profiles	37
3.2.2.5 Device	39
3.2.2.6 Multicast Groups	41
3.2.2.7 Gateway Fleet	43
3.2.2.8 Packets	44
3.3 Protocol Integration	47
3.3.1 BACnet Server	47
3.3.1.1 Server	47
3.3.1.2 BACnet Object	48
3.4 Network	49
3.4.1 Interface	49
3.4.1.1 Port	49
3.4.1.2 WLAN	52

3.4.1.3 Cellular (Cellular Version Only)	55
3.4.1.4 Loopback	58
3.4.1.5 VLAN Trunk	59
3.4.2 Firewall	59
3.4.2.1 Security	59
3.4.2.2 ACL	60
3.4.2.3 DMZ	62
3.4.2.4 Port Mapping (DNAT)	62
3.4.2.5 MAC Binding	63
3.4.3 DHCP	64
3.4.4 DDNS	65
3.4.5 Link Failover	66
3.4.5.1 SLA	66
3.4.5.2 Track	66
3.4.5.3 WAN Failover	68
3.4.6 VPN	68
3.4.6.1 DMVPN	69
3.4.6.2 IPsec	70
3.4.6.3 GRE	73
3.4.6.4 L2TP	74
3.4.6.5 PPTP	76
3.4.6.6 OpenVPN Client	78
3.4.6.7 OpenVPN Server	79
3.4.6.8 Certifications	82
3.5 System	83
3.5.1 General Settings	83
3.5.1.1 General	83
3.5.1.2 System Time	84
3.5.1.3 SMTP	85
3.5.1.4 Phone	85
3.5.1.5 Email	86
3.5.2 User Management	87
3.5.2.1 Account	87
3.5.2.2 User Management	87
3.5.3 SNMP	88
3.5.3.1 SNMP	88
3.5.3.2 MIB View	89
3.5.3.3 VACM	89
3.5.3.4 Trap	90
3.5.3.5 MIB	91
3.5.4 Device Management	91
3.5.4.1 Auto Provision	91
3.5.4.2 Management Platform	92
3.5.5 Events	93

3.5.5.1 Events	93
3.5.5.2 Events Settings	94
3.6 Maintenance	95
3.6.1 Tools	95
3.6.1.1 Ping	95
3.6.1.2 Traceroute	95
3.6.1.3 Qxdmlog	96
3.6.2 Schedule	96
3.6.3 Log	97
3.6.3.1 System Log	97
3.6.3.2 Log Settings	97
3.6.4 Upgrade	98
3.6.5 Backup and Restore	99
3.6.6 Reboot	100
3.7 APP	100
3.7.1 Python	100
3.7.1.1 Python	101
3.7.1.2 App Manager Configuration	101
3.7.1.3 Python App	102
3.7.2 Node-RED	103
3.7.2.1 Node-RED	104
Chapter 4 Application Examples	105
4.1 Restore Factory Defaults	105
4.2 Firmware Upgrade	106
4.3 Ethernet Connection	106
4.4 Cellular Connection (Cellular Version Only)	107
4.5 Wi-Fi Application Example	109
4.5.1 AP Mode	109
4.5.2 Client Mode	110
4.6 Packet Forwarder Configuration	111
4.7 Connect to Milesight IoT Cloud	113
4.8 Application Configuration	115
4.9 Device Configuration	117
4.10 Send Data to Device	118
4.11 Node-RED	121
4.11.1 Start the Node-RED	121
4.11.2 Send Data by Email	121

Chapter 1 Product Introduction

1.1 Overview

UG67 is a robust 8-channel outdoor LoRaWAN® gateway. Adopting SX1302 LoRa chip and high-performance quad-core CPU, UG67 supports connection with more than 2000 nodes. UG67 has line of sight up to 15 km and can cover about 2km in urbanized environment, which is ideally suited to smart office, smart building and many other outdoor applications.

UG67 supports not only multiple back-haul backups with Ethernet, Wi-Fi and cellular, but also has integrated mainstream network servers (such as The Things Industries, ChirpStack, etc.) and built-in network server and Milesight IoT Cloud for easy deployment.

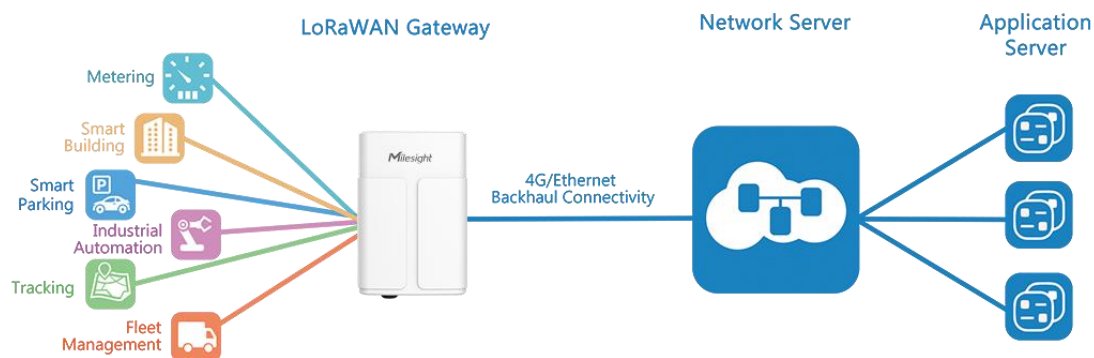

Figure 1-1

1.2 Advantages

Benefits

- Built-in industrial CPU and big memory
- Ethernet, 2.4GHz Wi-Fi and global 2G/3G/LTE options make it easy to get connected
- Embedded network server and compliant with several third party network servers
- MQTT, HTTP or HTTPS protocol for data transmission to application server
- Rugged enclosure, optimized for wall or pole mounting
- 3-year warranty included

Security & Reliability

- Automated failover/failback between Ethernet and Cellular
- Enable unit with security frameworks like IPsec/OpenVPN/GRE/L2TP/PPTP/ DMVPN
- Embedded hardware watchdog to automatically recover from various failure and ensure highest level of availability

Easy Maintenance

- Milesight DeviceHub provides easy setup, mass configuration, and centralized management of remote devices
- The user-friendly web interface design and various upgrading options help administrator to manage the device as easy as pie
- WEB GUI and CLI enable the admin to achieve quick configuration and simple management among a large quantity of devices
- Users can efficiently manage the remote devices on the existing platform through the industrial standard SNMP

Capabilities

- Link remote devices in an environment where communication technologies are constantly changing
- Industrial quad core 64-bit ARM Cortex-A53 processor, high-performance operating up to 1.5GHz with low power consumption, and 8GB eMMC available to support more applications
- Support wide operating temperature ranging from -40°C to 70°C/-40°F to 158°F

1.3 Specifications

Hardware System	
CPU	Quad-core 1.5GHz, 64-bit ARM Cortex-A53
Memory	8 GB eMMC Flash, 512 MB DDR4 RAM
LoRaWAN	
Antenna Connector	2 × 50 Ω N-Female External Connectors
Channel	8
Frequency Band	CN470/IN865/EU868/RU864/US915/AU915/KR920/AS923-1&2&3 &4
Sensitivity	-140dBm Sensitivity @292bps
Output Power	27dBm Max
Protocol	V1.0 Class A/Class B/Class C and V1.0.2 Class A/Class B/Class C
LBT	Support
Ethernet	
Ports	1 × RJ-45 (PoE PD supported)
Physical Layer	10/100/1000 Base-T (IEEE 802.3)

Data Rate	10/100/1000 Mbps (auto-sensing)
Interface	Auto MDI/MDIX
Mode	Full or half duplex (auto-sensing)
Wi-Fi Interfaces	
Antenna	Fully Integrated and Internal Antenna
Standards	IEEE 802.11 b/g/n, 2.4 GHz
	802.11b: 18 dBm +/-2.0 dBm (11 Mbps)
	802.11g: 15 dBm +/-2.0 dBm (6 Mbps)
	802.11g: 15 dBm +/-2.0 dBm (54 Mbps)
Tx Power	802.11n@2.4 GHz: 14 dBm +/-2.0 dBm (MCS0_HT20)
	802.11n@2.4 GHz: 14 dBm +/-2.0 dBm (MCS7_HT20)
	802.11n@2.4 GHz: 13 dBm +/-2.0 dBm (MCS0_HT40)
	802.11n@2.4 GHz: 13 dBm +/-2.0 dBm (MCS7_HT40)
Cellular Interfaces (Optional)	
Antenna	Internal Antenna
SIM Slots	1
GPS	
Antenna	Internal Antenna
Sensitivity	-167dBm@Tracking, -149dBm@Acquisition, -161dBm@Re-acquisition
Position Accuracy	<2.5m CEP
Software	
Network Protocols	PPPoE, SNMP v1/v2c/v3, TCP, UDP, DHCP, DDNS, HTTP, HTTPS, DNS, SNTP, Telnet, SSH, MQTT, BACnet/IP, etc.
VPN Tunnel	DMVPN/IPsec/OpenVPN/PPTP/L2TP/GRE
Firewall	ACL/DMZ/Port Mapping/MAC Binding
Management	Web, CLI, SMS, On-demand dial up, DeviceHub, Milesight IoT Cloud, Yeastar Workplace Platform, Milesight Development Platform
App	Python SDK, Node-RED
Power Supply and Consumption	
Power Supply	1. 1 × 802.3 af PoE Input 2. 12 VDC with M12 Connector
Consumption	Typical 3.6W, Max 4.8W

Physical Characteristics

Ingress Protection IP67

Dimensions 240 x 164 x 90.9 mm

Mounting Wall or Pole Mounting

Others

Reset Button 1 × RST

LED Indicators 1 × SYS, 1 × LoRa, 1 × LTE

Built-in Watchdog, RTC, Timer

Environmental

Operating -40°C to +70°C (-40°F to +158°F)

Temperature Reduced cellular performance above 60°C

Storage -40°C to +85°C (-40°F to +185°F)

Temperature

Ethernet Isolation 1.5 kV RMS

Relative Humidity 0% to 95% (non-condensing) at 25°C/77°F

1.4 Dimensions (mm)

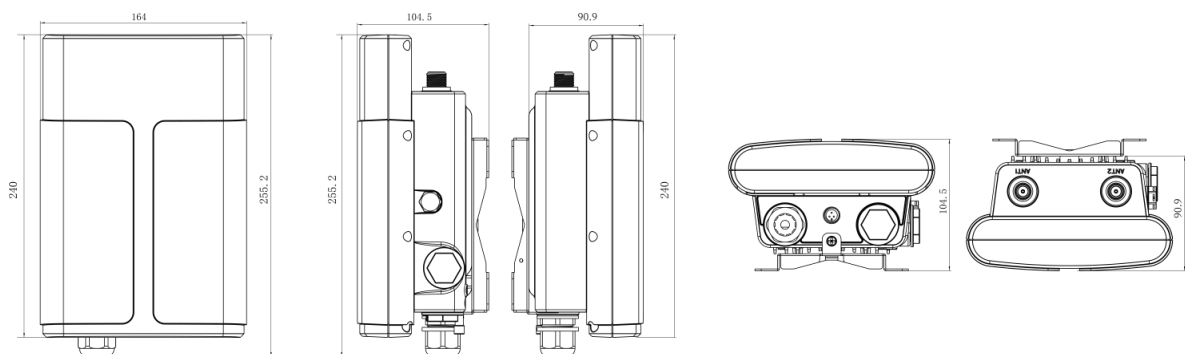

Chapter 2 Access to Web GUI

This chapter explains how to access to Web GUI of the UG67.

Username: **admin**

Password: **password**

2.1 Wireless Access

1. Enable Wireless Network Connection on your computer and search for access point **"Gateway_*****"** to connect it.
2. Open a Web browser on your PC (Chrome is recommended) and type in the IP address **192.168.1.1** to access the web GUI.
3. Enter the username and password, click "Login".

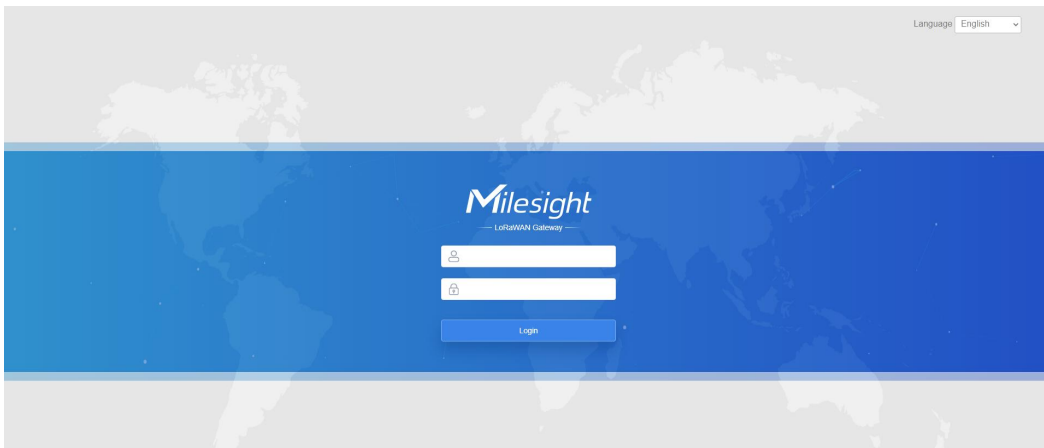

If you enter the username or password incorrectly more than 5 times, the login page will be locked for 10 minutes.

4. After logging the web GUI, you can view system information and perform configuration of the gateway. It's suggested that you change the password for the sake of security.

System Information	
Model	UG67-L00E-868M
Region	EU868
Serial Number	6222C4522590
Firmware Version	60.0.0.41-14
Hardware Version	V1.4
Local Time	2023-03-02 11:09:02 Thursday
Uptime	17:11:08
CPU Load	3%
RAM (Capacity/Available)	512MB/107MB(20.9%)
eMMC (Capacity/Available)	3.0G/2.8G(91.08%)
GPS	-

2.2 Wired Access

Connect PC to UG67 ETH port through PoE injector to access the web GUI of gateway. The following steps are based on Windows 10 system for your reference.

1. Go to “Control Panel” → “Network and Internet” → “Network and Sharing Center”, then click “Ethernet” (May have different names).

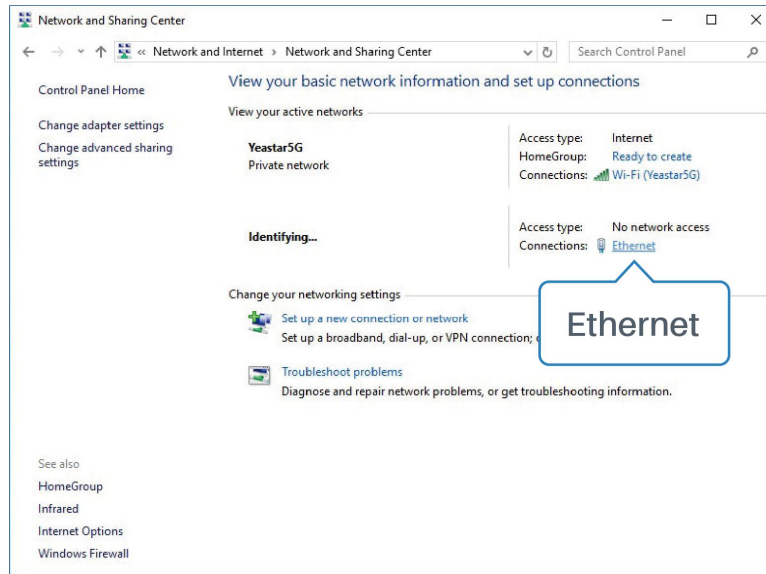

2. Go to “Properties” → “Internet Protocol Version 4(TCP/IPv4) ”and select “Use the following IP address”, then assign a static IP manually within the same subnet of the gateway.

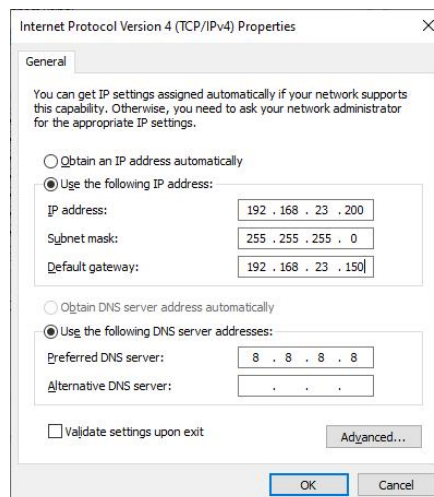

3. Open a Web browser on your PC (Chrome is recommended) and type in the IP address **192.168.23.150** to access the web GUI, enter the username and password, click “Login”.

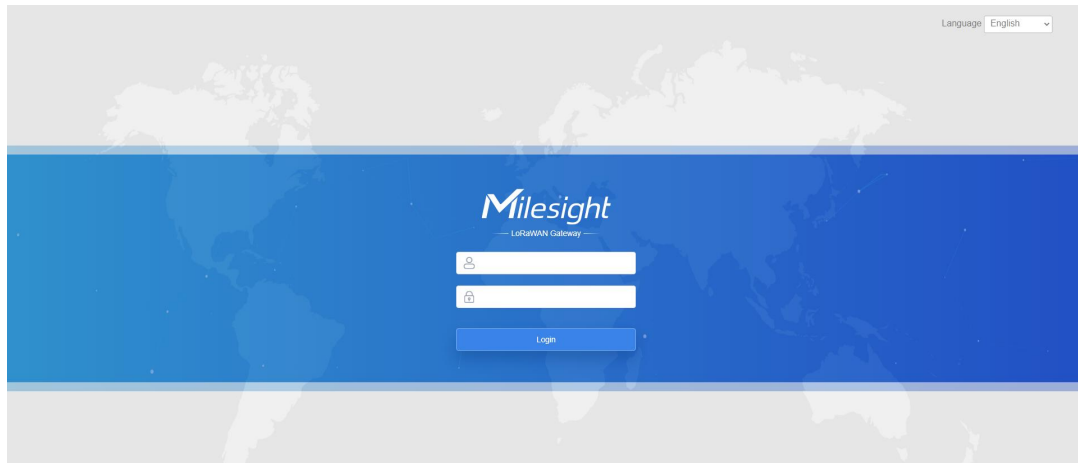

If you enter the username or password incorrectly more than 5 times, the login page will be locked for 10 minutes.

4. After logging the web GUI, you can view system information and perform configuration of the gateway. It's suggested that you change the password for the sake of security.

System Information	
Model	UG67-L00E-868M
Region	EU868
Serial Number	6222C4522590
Firmware Version	60.0.0.41-14
Hardware Version	V1.4
Local Time	2023-03-02 11:09:02 Thursday
Uptime	17:11:08
CPU Load	3%
RAM (Capacity/Available)	512MB/107MB(20.9%)
eMMC (Capacity/Available)	3.0G/2.8G(91.08%)
GPS	-

Chapter 3 Web Configuration

3.1 Status

3.1.1 Overview

You can view the system information of the gateway on this page.

System Information	
Model	UG67-915M
Region	AU915
Serial Number	6222D3914187
Firmware Version	60.0.0.42-r5
Hardware Version	V1.4
Local Time	2024-02-21 20:25:25 Wednesday
Uptime	1days,05:53:13
CPU Load	3%
RAM (Capacity/Available)	512MB/109MB (21.29%)
eMMC (Capacity/Available)	8.0GB/6.5GB (81.86%)
GPS	-

Figure 3-1-1-1

System Information	
Item	Description
Model	Show the model name of gateway.
Region	Show the LoRaWAN® frequency region of gateway.
Serial Number	Show the serial number of gateway.
Firmware Version	Show the currently firmware version of gateway.
Hardware Version	Show the currently hardware version of gateway.
Local Time	Show the currently local time of system.
Uptime	Show the information on how long the gateway has been running.
CPU Load	Show the current CPU utilization of the gateway.
RAM (Capacity/Available)	Show the RAM capacity and the available RAM memory.
eMMC (Capacity/Available)	Show the eMMC capacity and the available eMMC memory.
GPS	Show GPS data of the gateway.

Table 3-1-1-1 System Information

When Milesight UPS is connected to the device, the UPS basic information will also show on the Status page. For more details please refer to *Milesight UPS User Guide*.

UPS	
Model	-
Serial Number	-
Firmware Version	-
Hardware Version	-
Power Status	Unconnected
Remaining Battery	-

Figure 3-1-1-2

3.1.2 Cellular (Cellular Version Only)

You can view the cellular network status of gateway on this page.

Modem	
Status	Ready
Model	EC25
Version	EC25ECGAR06A07M1G
Signal Level	26asu (-61dBm)
Register Status	Registered (Home network)
IMEI	860425047368939
IMSI	460019425301842
ICCID	89860117838009934120
ISP	CHN-UNICOM
Network Type	LTE
PLMN ID	
LAC	5922
Cell ID	340db80

Figure 3-1-2-1

Modem Information

Item	Description
------	-------------

Status	Show corresponding detection status of module and SIM card.
Model	Show the model name of cellular module.
Version	Show the version of cellular module.
Signal Level	Show the cellular signal level.
Register Status	Show the registration status of SIM card.
IMEI	Show the IMEI of the module.
IMSI	Show IMSI of the SIM card.
ICCID	Show ICCID of the SIM card.
ISP	Show the network provider which the SIM card registers on.
Network Type	Show the connected network type, such as LTE, 3G, etc.
PLMN ID	Show the current PLMN ID, including MCC, MNC, LAC and Cell ID.
LAC	Show the location area code of the SIM card.
Cell ID	Show the Cell ID of the SIM card location.

Table 3-1-2-1 Modem Information

Network	
Status	Connected
IP Address	10.53.241.18
Netmask	255.255.255.252
Gateway	10.53.241.17
DNS	218.104.128.106
Connection Duration	0 days, 00:04:26

Figure 3-1-2-2

Network Status	
Item	Description
Status	Show the connection status of cellular network.
IP Address	Show the IP address of cellular network.
Netmask	Show the netmask of cellular network.
Gateway	Show the gateway of cellular network.
DNS	Show the DNS of cellular network.
Connection Duration	Show information on how long the cellular network has been connected.

Table 3-1-2-2 Network Status

3.1.3 Network

On this page you can check the Ethernet port status of the gateway.

Overview	Cellular	Network	WLAN	VPN	Host List		
WAN							
Port	Status	Type	IP Address	Netmask	Gateway	DNS	Duration
eth 0	up	Static	192.168.22.112	255.255.255.0	192.168.22.1	8.8.8.8	02m 14s

Figure 3-1-3-1

Network	
Item	Description
Port	Show the name of the Ethernet port.
Status	Show the status of the Ethernet port. "Up" refers to a status that WAN is enabled and Ethernet cable is connected. "Down" means Ethernet cable is disconnected or WAN function is disabled.
Type	Show the dial-up type of the Ethernet port.
IP Address	Show the IP address of the Ethernet port.
Netmask	Show the netmask of the Ethernet port.
Gateway	Show the gateway of the Ethernet port.
DNS	Show the DNS of the Ethernet port.
Duration	Show the information about how long the Ethernet cable has been connected to the Ethernet port when the port is enabled. Once the port is disabled or Ethernet cable is disconnected, the duration will stop.

Table 3-1-3-1 WAN Status

3.1.4 WLAN

You can check Wi-Fi status on this page, including the information of access point and client.

Overview	Cellular	Network	WLAN	VPN	Host List
WLAN Status					
Wireless Status	Enabled				
MAC Address	24:e1:24:f0:e2:26				
Interface Type	AP				
SSID	Gateway_F0E226				
Channel	Auto				
Encryption Type	No Encryption				
Status	Up				
IP Address	192.168.1.1				
Netmask	255.255.255.0				
Connection Duration	4 days, 21:12:11				

Figure 3-1-4-1

WLAN Status	
Item	Description
Wireless Status	Show the wireless status.
MAC Address	Show the MAC address.
Interface Type	Show the interface type, such as "AP" or "Client".
SSID	Show the SSID.
Channel	Show the wireless channel.
Encryption Type	Show the encryption type.
Status	Show the connection status.
IP Address	Show the IP address of the gateway.
Netmask	Show the wireless MAC address of the gateway.
Gateway	Show the gateway address in wireless network.
Connection Duration	Show information on how long the Wi-Fi network has been connected.

Table 3-1-4-1 WLAN Status

Associated Stations		
IP Address	MAC Address	Connection Duration

Figure 3-1-4-2

Associated Stations	
Item	Description
IP Address	Show the IP address of access point or client.
MAC Address	Show the MAC address of the access point or client.
Connection Duration	Show information on how long the Wi-Fi network has been

connected.

Table 3-1-4-2 WLAN Status

3.1.5 VPN

You can check VPN status on this page, including PPTP, L2TP, IPsec, OpenVPN and DMVPN.

Overview	Cellular	Network	WLAN	VPN	Host List
PPTP Tunnel					
Name	Status	Local IP	Remote IP		
pptp_1	Disconnected	-	-		
pptp_2	Disconnected	-	-		
pptp_3	Disconnected	-	-		
L2TP Tunnel					
Name	Status	Local IP	Remote IP		
l2tp_1	Disconnected	-	-		
l2tp_2	Disconnected	-	-		
l2tp_3	Disconnected	-	-		

Figure 3-1-5-1

IPsec Tunnel				
Name	Status	Local IP	Remote IP	
ipsec_1	Disconnected	-	-	
ipsec_2	Disconnected	-	-	
ipsec_3	Disconnected	-	-	
OpenVPN Client				
Name	Status	Local IP	Remote IP	
openvpn_1	Disconnected	-	-	
openvpn_2	Disconnected	-	-	
openvpn_3	Disconnected	-	-	

Figure 3-1-5-2

GRE Tunnel				
Name	Status	Local IP	Remote IP	
gre_1	Disconnected	-	-	
gre_2	Disconnected	-	-	
gre_3	Disconnected	-	-	

DMVPN Tunnel				
Name	Status	Local IP	Remote IP	
dmvpn	Disconnected	-	-	

Figure 3-1-5-3

VPN Status	
Item	Description
Name	Show the name of the VPN tunnel.
Status	Show the status of the VPN tunnel.
Local IP	Show the local tunnel IP of VPN tunnel.
Remote IP	Show the remote tunnel IP of VPN tunnel.

Table 3-1-5-1 VPN Status

3.1.6 Host List

You can view the host information on this page.

Overview	Cellular	Network	WLAN	VPN	Host List
DHCP Leases					
IP		MAC		Lease Remaining Time	
MAC Binding					
IP			MAC		

Figure 3-1-6-1

Host List	
Item	Description
DHCP Leases	
IP Address	Show IP address of DHCP client
MAC Address	Show MAC address of DHCP client
Lease Time Remaining	Show the remaining lease time of DHCP client.
MAC Binding	
IP & MAC	Show the IP address and MAC address set in the Static IP list of DHCP service.

Table 3-1-6-1 Host List Description

3.2 LoRaWAN

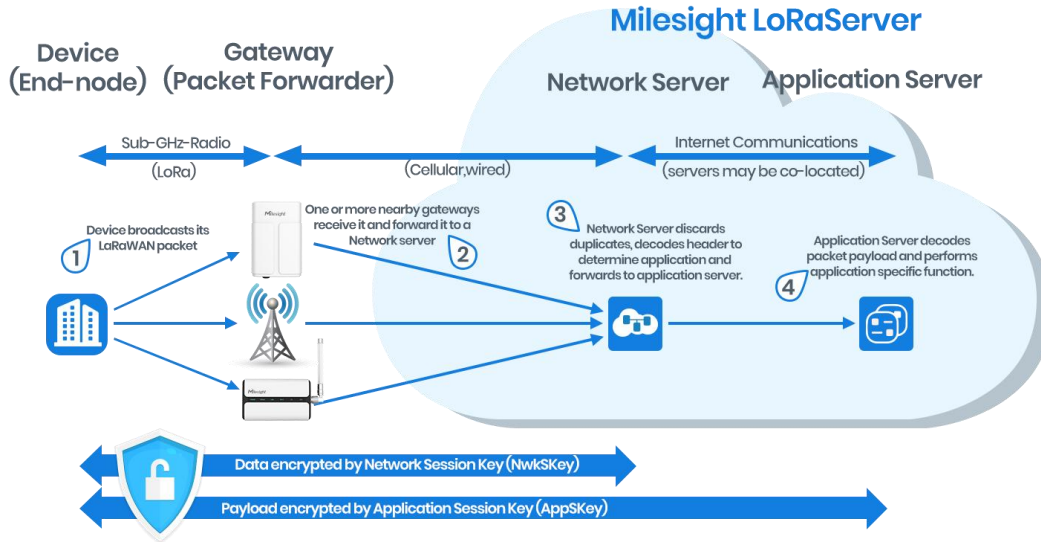

3.2.1 Packet Forwarder

3.2.1.1 General

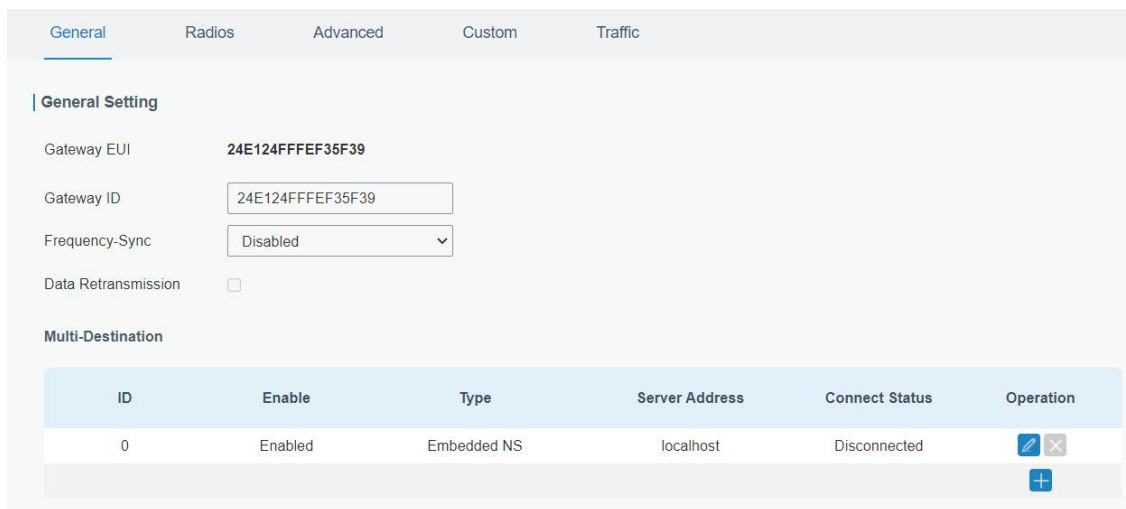

Figure 3-2-1-1

General Settings	
Item	Description
Gateway EUI	Show the unique identifier of the gateway and it's non-editable.
Gateway ID	Fill in the corresponding ID which you've used for registering gateway to the remote network server. It is usually the same as gateway EUI and can be changed.

Frequency-Sync	Sync frequency configurations from the network server by selecting the corresponding multi-destination ID.
Data Retransmission	When the gateway connects to a single Chirpstack/Semtech/Remote Embedded NS/Basic Station type package forwarder, it supports data storage up to 1 million pieces of data when network is disconnected and re-transmits the data after network recovery.
Multi-Destination	The gateway will forward the data to the network server address that was created and enabled in the list.
Connection Status	Show the connection status of package forwarder.

Table 3-2-1-1 General Setting Parameters

Related Configuration Example

[Packet forwarder configuration](#)

3.2.1.2 Radios

The screenshot shows the 'Radio Channel Setting' configuration page. At the top, there is a 'Region' dropdown menu set to 'US915' and a 'Noise Analyzer' toggle switch that is turned on. Below this is a table with two columns: 'Name' and 'Center Frequency/MHz'. The table contains two rows: 'Radio 0' with a center frequency of 904.3 and 'Radio 1' with a center frequency of 905.1.

Figure 3-2-1-2

Radios-Radio Channel Setting		
Item	Description	Default
Region	Choose the LoRaWAN® frequency plan used for the upstream and downlink frequencies and datarates. Available channel plans depend on the gateway's model.	Based on the gateway's model
Center Frequency	Change the frequencies to receive packets from LoRaWAN® nodes.	Based on what is specified in the LoRaWAN® regional parameters document

Table 3-2-1-2 Radio Channels Setting Parameters

Multi Channels Setting			
Enable	Index	Radio	Frequency/MHz
<input checked="" type="checkbox"/>	0	Radio 0	923.2
<input checked="" type="checkbox"/>	1	Radio 0	923.4
<input checked="" type="checkbox"/>	2	Radio 0	923.6
<input checked="" type="checkbox"/>	3	Radio 1	922.2
<input checked="" type="checkbox"/>	4	Radio 1	922.4
<input checked="" type="checkbox"/>	5	Radio 1	922.6
<input checked="" type="checkbox"/>	6	Radio 1	922.8
<input checked="" type="checkbox"/>	7	Radio 1	923.0

Figure 3-2-1-3

Radios-Multi Channel Setting		
Item	Description	Default
Enable	Click to enable this channel to transmit packets.	Enabled
Index	Indicate the ordinal of the list.	/
Radio	Choose Radio 0 or Radio 1 as center frequency.	Radio 0
Frequency/MHz	Enter the frequency of this channel. Range: center frequency \pm 0.4625.	Based on the LoRaWAN® regional document

Table 3-2-1-3 Multi Channel Setting Parameters

LoRa Channel Setting				
Enable	Radio	Frequency/MHz	Bandwidth/KHz	Spread Factor
<input checked="" type="checkbox"/>	Radio 0	923.8	250KHZ	SF7

Figure 3-2-1-4

Radios-LoRa Channel Setting		
Item	Description	Default
Enable	Click to enable this channel to transmit packets.	Enabled
Radio	Choose Radio 0 or Radio 1 as center frequency.	Radio 0
Frequency/MHz	Enter the frequency of this channel. Range: center frequency \pm 0.9.	Based on the supported frequency
Bandwidth/MHz	Enter the bandwidth of this channel.	500KHz
Spread Factor	Choose the selectable spreading factor. The channel with large spreading factor corresponds to a low rate, while the small one corresponds to a high rate.	Based on what is specified in the LoRaWAN® regional parameters document

Table 3-2-1-4 LoRa Channel Setting Parameters

Enable	Radio	Frequency/MHz	Bandwidth/KHz	DataRate
<input checked="" type="checkbox"/>	Radio 0	924.0	125KHZ	50000

Figure 3-2-1-5

Radios-FSK Channel Setting		
Item	Description	Default
Enable	Click to enable this channel to transmit packets.	Disabled
Radio	Choose Radio 0 or Radio 1 as center frequency.	Radio 0
Frequency/MHz	Enter the frequency of this channel. Range: center frequency±0.9.	Based on the supported frequency
Bandwidth/MHz	Enter the bandwidth of this channel. Recommended value: 125KHz, 250KHz, 500KHz	Based on the supported frequency
Data Rate	Enter the data rate. Range: 500-25000.	500

Table 3-2-1-5 FSK Channel Setting Parameters

3.2.1.3 Noise Analyzer

Noise analyzer is used for scanning the noise of every frequency channel and giving a diagram for users to analyze the environment interference condition and select best deployment. RSSI indicates the sensitivity for every channel. **Lower the RSSI value, better the signal. It's not suggested to enable this feature when using package forwarder since it will affect the downlink transmission.**

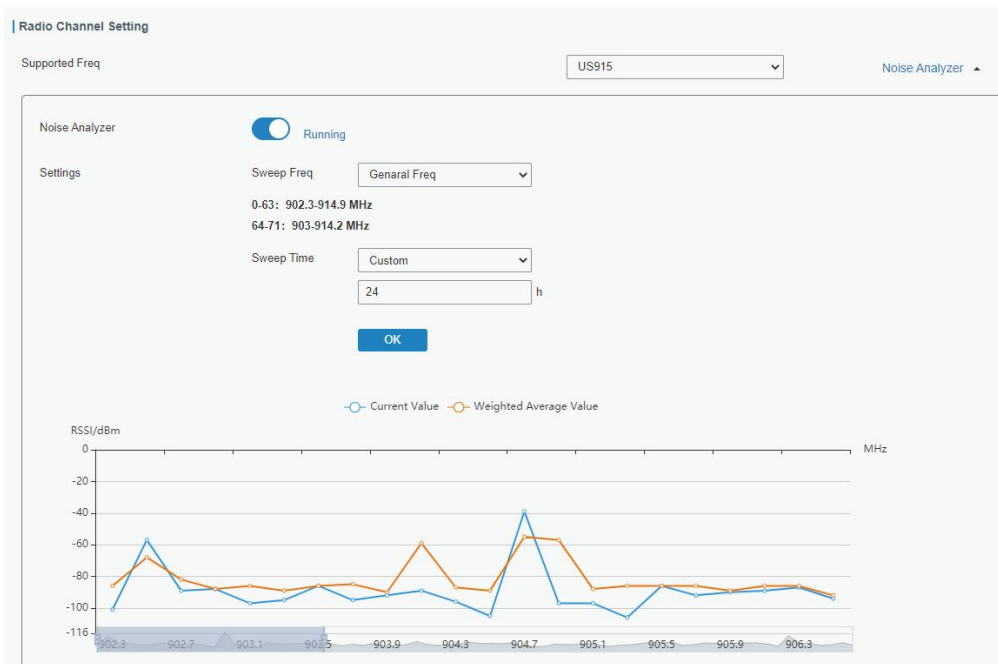

Figure 3-2-1-6

Noise Analyzer		
Item	Description	Default
Enable	Click to enable noise analyzer feature.	Disabled
Sweep Freq	Select the frequency sweeping range. General Freq: frequencies based on the LoRaWAN® regional parameters document Custom: custom the frequency range	General Freq
Sweep Time	Enable the noise analyzer continuously or within a period of time. If Custom is selected, the noise analyzer will stop automatically after the pre-configured time. Note: It's suggested to custom the time since noise analyzer feature will affect the normal data transmission.	Custom/24h

Table 3-2-1-6 Noise Analyzer Setting Parameters

3.2.1.4 Advanced

This section is about settings in details of beacon transmitting and validating.

General	Radios	Advanced	Custom	Traffic
 Beacon Setting				
Beacon Period		0	s	
Beacon Freq		508300000	Hz	
Beacon Datarate		SF10		
Beacon Channel Number		3		
Beacon Freq Step		200000	Hz	
Beacon Bandwidth		125000	Hz	
Beacon TX Power		14	dBm	

Figure 3-2-1-7

Advanced-Beacon Setting		
Item	Description	Default
Beacon Period	Interval of gateway sending beacons for Class B device time synchronization. 0 means the gateway will not send beacons.	0
Beacon Freq	The frequency of beacons.	Based on the supported

		frequency
Beacon Datarate	The datarate of beacons.	Based on the supported frequency
Beacon Channel Number	When selecting Custom, it allows users to custom range from 1 to 8.	1
Beacon Freq Step	Frequency interval of beacons.	200000
Beacon Bandwidth	The bandwidth of beacons. Unit: Hz	12500 Hz
Beacon TX Power	The TX power of beacons.	Based on the supported frequency

Table 3-2-1-7 Advanced-Beacon Parameters

Intervals Setting

Keep Alive Interval s

Stat Interval s

Push Timeout ms

Forward CRC Setting

Forward CRC Disabled

Forward CRC Error

Forward CRC Valid

Figure 3-2-1-8

Item	Description	Default
Keep Alive Interval	Enter the interval of keepalive packet which is sent from gateway to network server to keep the connection stable and alive. Range: 1-3600.	10
Stat Interval	Enter the interval to update the network server with gateway statistics. Range: 1-3600.	30
Push Timeout	Enter the timeout to wait for the response from server after the gateway sends data of node. Rang: 1-1999.	100
Forward CRC Disabled	Enable to send packets received with CRC disabled to the network server.	Disabled
Forward CRC	Enable to send packets received with CRC errors to	Disabled

Error	the network server.	
Forward CRC Valid	Enable to send packets received with CRC valid to the network server.	Enabled

Table 3-2-1-8 Advanced Parameters

LBT Settings

Enable

RSSI Target dBm

Figure 3-2-1-9

Item	Description	Default
Enable	Enable or disable LBT feature. Listen before talk (LBT) is used to detect whether the downlink channel is idle and avoid channel access conflicts. Note: AU915 and US915 do not support LBT feature.	Disabled
RSSI Target	Enter the criteria of an idle channel. If actual RSSI of a channel is less than the criteria/target, the channel is considered as idle. Range: -120~0	-80

Table 3-2-1-9 Advanced-LBT Parameters

3.2.1.5 Custom

When Custom Configuration mode is enabled, you can write your own packet forwarder configuration file in the edit box to configure packet forwarder. Click "Save" to save your custom configuration file content, and click "Apply" to take effect. You can click "Clear" to erase all content in the edit box. If you don't know how to write configuration file, please click "Example" to go to reference page.

Note: customized configuration will overwrite the packet forward configurations of web GUI.

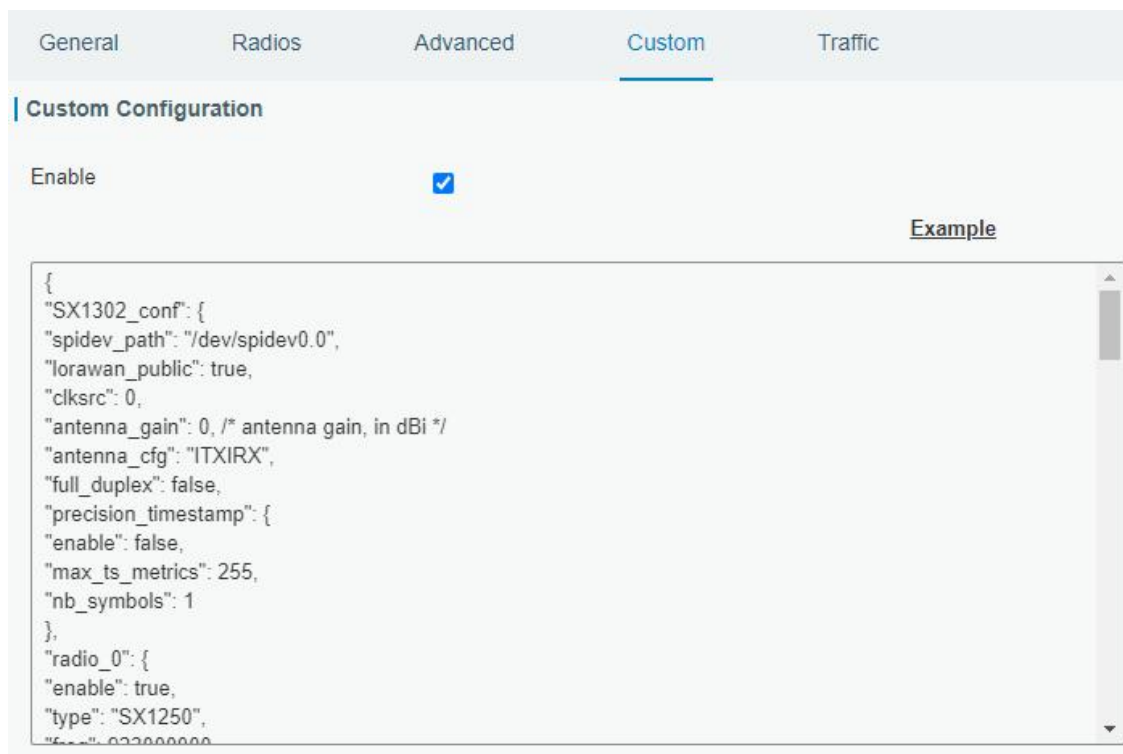

Figure 3-2-1-10

3.2.1.6 Traffic

When navigating to the traffic page, any recent traffic received by the gateway will display. To watch live traffic, click **Refresh**.

Traffic Setting									
Rfch	Direction	Time	Ticks	Frequency	Datarate	Coderate	RSSI	SNR	
1	up	-	83002508	922.8	SF9BW125	4/5	-103	-13.2	
1	up	-	71108156	922.6	SF9BW125	4/5	-102	-13.2	
1	up	-	35426956	922.8	SF9BW125	4/5	-103	-9.8	
1	up	-	3171639508	922.6	SF9BW125	4/5	-100	-10.5	
1	up	-	3159744804	922.6	SF9BW125	4/5	-102	-13.0	
1	up	-	3155781348	922.6	SF9BW125	4/5	-101	-12.2	
1	up	-	3147851660	922.6	SF9BW125	4/5	-102	-13.8	
1	up	-	3143888916	922.8	SF9BW125	4/5	-102	-13.2	
1	up	-	3139922740	922.8	SF9BW125	4/5	-100	-12.2	
1	up	-	3124065788	922.8	SF9BW125	4/5	-100	-12.8	

Figure 3-2-1-11

Item	Description
Refresh	Click to obtain the latest data.
Clear	Click to clear all data.
Rfch	Show the channel of this packet.
Direction	Show the direction of this packet.
Time	Show the receiving time of this packet.
Ticks	Show the ticks of this packet.

Frequency	Show the frequency of the channel.
Datarate	Show the datarate of the channel.
Coderate	Show the coderate of this packet.
RSSI	Show the received signal strength.
SNR	Show the signal to noise ratio of this packet.

Table 3-2-1-10 Traffic Parameters

3.2.2 Network Server

3.2.2.1 General

General Setting

Enable

Platform Mode

NetID

Join Delay sec

RX1 Delay sec

Lease Time hh-mm-ss

Log Level

Global Channel Plan Setting

Channel Plan

Channel

Figure 3-2-2-1

Item	Description	Default
General Setting		
Enable	Click to enable Network Server mode.	Enabled
Platform Mode	Enabled to connect gateway to Milesight IoT Cloud or Yeastar Workplace platform.	Disabled
NetID	Enter the network identifier.	010203
Join Delay	Enter the interval time between when the end-device sends a Join_request_message to network server and when the end-device prepares to open RX1 to receive the Join_accept_message sent from network server.	5
RX1 Delay	Enter the interval time between when the	1

	end-device sends uplink packets and when the end-device prepares to open RX1 to receive the downlink packet.	
Lease Time	Enter the amount of time till a successful join expires. The format is hours-minutes-seconds. If the join-type is OTAA, then the end-devices need to join the network server again when it exceeds the lease time.	876000-00-00
Log level	Choose the log level.	Info
Channel Plan Setting		
Channel Plan	Choose LoRaWAN® channel plan used for the upstream and downlink frequencies and datarates. Available channel plans depend on the gateway's model.	Depend on the gateway's frequency
Channel	<p>Allow end devices to communicate with specific frequency channels.</p> <p>Leave it blank means using all the default standard usable channels specified in the LoRaWAN® regional parameters document. It allows to enter the index of the channels.</p> <p>Examples:</p> <p>1, 40: Enabling Channel 1 and Channel 40</p> <p>1-40: Enabling Channel 1 to Channel 40</p> <p>1-40, 60: Enabling Channel 1 to Channel 40 and Channel 60</p>	Depend on the gateway's frequency

Table 3-2-2-1 General Parameters

Note: For some regional variants, if allowed by your LoRaWAN® region, you can use Additional Plan to configure additional channels undefined by the LoRaWAN® Regional Parameters, like EU868 and KR920, as the following picture shows:

Frequency(MHz)	Min Datarate	Max Datarate	Operation

Figure 3-2-2-2

Additional Channels		
Item	Description	Default
Frequency/MHz	Enter the frequency of the additional plan.	Null.
Max Datarate	Enter the max datarate for the end-device. The range is based on what is specified in the LoRaWAN® regional parameters document.	DR0(SF12,125kHz)
Min Datarate	Enter the min datarate for the end-device.	DR3(SF9,125kHz)

	The range is based on what is specified in the LoRaWAN® regional parameters document.	
--	---	--

Table 3-2-2-2 Additional Plan Parameters

3.2.2.2 Application

An application is a collection of devices with the same purpose/of the same type. Users can add a series of devices to the same application which needs to send to the same server.

You can edit the application by clicking  or create a new application by clicking .

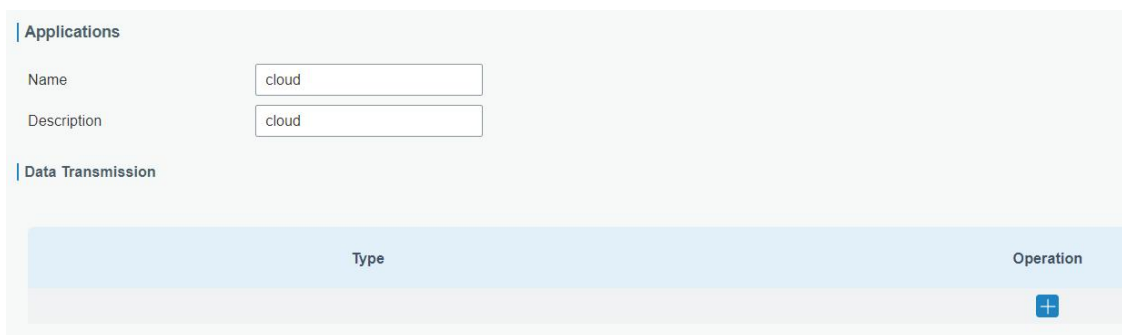

Figure 3-2-2-3

Application	
Item	Description
Name	Enter the name of the application profile. E.g smoker-sensor-app.
Description	Enter the description of this application. E.g an application for smoker sensor.
Data Transmission	Data will be sent to your custom server using the MQTT, HTTP, HTTPS or BACnet/IP protocol. One application can add 3 data transmissions at most and every protocol can be selected only once.

Table 3-2-2-3 Application Parameters

MQTT Integration

Type MQTT ▾

Status -

| General

Broker Address

Broker Port

Client ID

Connection Timeout/s

Keep Alive Interval/s

| User Credentials

Enable

Username

Password

| TLS

Enable

Mode CA signed server certificate ▾

Figure 3-2-2-4

| Topic

Data Type	topic	
Uplink data	<input type="text"/>	QoS 0 ▾
Downlink data	<input type="text"/>	QoS 0 ▾
Multicast downlink data	<input type="text"/>	QoS 0 ▾
Join notification	<input type="text"/>	QoS 0 ▾
ACK notification	<input type="text"/>	QoS 0 ▾
Error notification	<input type="text"/>	QoS 0 ▾
Request data	<input type="text" value="/event/request"/>	QoS 0 ▾
Response data	<input type="text" value="/event/response"/>	QoS 0 ▾

Figure 3-2-2-5

MQTT Settings	
Item	Description
General	
Broker Address	MQTT broker address to receive data.
Broker Port	MQTT broker port to receive data.

Client ID	Client ID is the unique identity of the client to the server. It must be unique when all clients are connected to the same server, and it is the key to handle messages at QoS 1 and 2.
Connection Timeout/s	If the client does not get a response after the connection timeout, the connection will be considered as broken. The Range: 1-65535
Keep Alive Interval/s	After the client is connected to the server, the client will send heartbeat packet to the server regularly to keep alive. Range: 1-65535
User Credentials	
Enable	Enable user credentials.
Username	The username used for connecting to the MQTT broker.
Password	The password used for connecting to the MQTT broker.
TLS	
Enable	Enable the TLS encryption in MQTT communication.
Mode	Select from "Self signed certificates", "CA signed server certificate". CA signed server certificate: verify with the certificate issued by Certificate Authority (CA) that pre-loaded on the device. Self signed certificates: upload the custom CA certificates, client certificates and secret key for verification.
Topic	
Data Type	Data type to communicate with MQTT broker: Uplink Data: receive device uplink packets Downlink Data: send downlink commands to device Multicast Downlink Data: send downlink commands to multicast group Join Notification: receive join request packets from devices ACK Notification: receive ACK packets from devices Error Notification: receive error packets from devices Request data: send requests to enquire and configure the gateway NS Response data: receive the request responses
Topic	Topic name of the data type used for publishing.
QoS	QoS 0 – Only Once This is the fastest method and requires only 1 message. It is also the most unreliable transfer mode. QoS 1 – At Least Once This level guarantees that the message will be delivered at least once, but may be delivered more than once. QoS 2 – Exactly Once QoS 2 is the highest level of service in MQTT. This level guarantees that each message is received only once by the intended recipients. QoS 2 is the safest and slowest quality of service level.

Table 3-2-2-4 MQTT Settings Parameters

Note: if MQTT broker type is HiveMQ, please enable TLS and set the option as **CA signed server certificate**.

HTTP/HTTPS Integration

The screenshot displays the configuration interface for HTTP/HTTPS integration. It is divided into two main sections: 'HTTP Header' and 'URL'.

HTTP Header Section:

Header Name	Header Value	Operation
		+

URL Section:

Data Type	URL
Uplink data	<input type="text"/>
Join notification	<input type="text"/>
ACK notification	<input type="text"/>
Error notification	<input type="text"/>

Figure 3-2-2-6

HTTP/HTTPS Settings	
Item	Description
HTTP Header	
Header Name	A core set of fields in the HTTP header.
Header Value	Value of the HTTP header.
URL	
Data Type	Data type sent to HTTP/HTTPS server.
Topic	Topic name of the data type used for publishing.
URL	HTTP/HTTPS server URL to receive data.

Table 3-2-2-5 HTTP/HTTPS Settings Parameters

Related Configuration Example

[Application configuration](#)

3.2.2.3 Payload Codec

Payload Codec provides the inbuilt payload codec library of Milesight LoRaWAN devices to decode and encode the data easily. Users can also customize the payload codec of other brands of devices or adjust the uplink and downlink contents as requirements.

Inbuilt Payload Codec Library

Library Version: 1.0.0

Obtaining Type:

Note: Ensure that the Internet access is available.

Name	Payload decoder function	Payload encoder function	Details
AM103 & AM103L	✓	✓	!
AM104	✓	✓	!
AM107	✓	✓	!
AM307	✓	✓	!
AM308	✓	✓	!
AM319-HCHO	✓	✓	!
AM319-HCHO-IR	✓	✓	!
AM319-O3	✓	✓	!
EM300-TH	✓	✓	!
WS101	✓	✓	!

Showing 1 to 10 of 30 rows rows per page < 1 2 3 >

Figure 3-2-2-7

Inbuilt Payload Codec Library	
Item	Description
Library Version	Show the version of the Milesight LoRaWAN node payload codec library.
Obtaining Type	Select the type to update the Milesight devices payload codec library. Online: update automatically if gateway detects there is version update every time gateway powers on and accesses the Internet. Users can also click Obtain button to check update status manually. Local Upload: click Browse to upload the zip format payload codec package and click Import to update the library.
Name	Show the corresponding Milesight product model of the payload codec.
Payload decoder/encoder function	Show if decoder and encoder are existed.
Details	Show the details of decoder and encoder. If this does not meet your requirement, please customize your payload codec.

Table 3-2-2-6 Inbuilt Payload Codec Library Parameters

Name

Description

Template

Payload decoder

Payload decoder function

```

1 // Decode decodes an array of bytes into an object.
// - fPort contains the LoRaWAN fPort number
// - bytes is an array of bytes, e.g. [225, 230, 255, 0]
// The function must return an object, e.g. {"temperature": 22.5}
function Decode(fPort, bytes) {
  return {};
}

```

Payload encoder

Payload encoder function

```

1 // Encode encodes the given object into an array of bytes.
// - fPort contains the LoRaWAN fPort number
// - obj is an object, e.g. {"temperature": 22.5}
// The function must return an array of bytes, e.g. [225, 230, 255, 0]
function Encode(fPort, obj) {
  return [];
}

```

Payload Codec Test

```

1 // input decoded test payload or encoded test payload
// decoded bytes
// 01 75 5C 03 67 34 01 04 68 65 05 6A 49 00 06 65 1C 00 79 00 14 00 07 7D E7 04 08 7D 07 00 09 73 3F 27
// encoded obj's
// t

```

Figure 3-2-2-8

Custom Payload Codec	
Item	Description
Name	Enter the unique name of the custom payload codec.
Description	Enter the description of this payload codec.
Template	Select an existing inbuilt payload codec as a template.
Payload Decoder/Encoder Function	Customize the device payload decoder or encoder. Note that the function header should be the same as the example on the blanks.
Payload Codec test	Disable or enable payload codec test.
fPort	Application port of LoRaWAN devices. It's 85 by default for Milesight LoRaWAN devices.
Decode	Enter the hex format raw data and click Decode to check the result.
Encode	Enter the JSON format command and check Encode to check the result.

Table 3-2-2-7 Custom Payload Codec Parameters

3.2.2.4 Profiles

A Profile defines the device capabilities and boot parameters that are needed by the Network Server for setting the LoRaWAN® radio access service. These information elements shall be provided by the end-device manufacturer. UG67 has pre-configured 8 device files and users can also create a new device profile.

Name	Max TXPower	Join Type	Class Type	Operation
ClassA-ABP	0	ABP	Class A	[edit] [delete]
ClassA-OTAA	0	OTAA	Class A	[edit] [delete]
ClassB-ABP	0	ABP	Class A Class B	[edit] [delete]
ClassB-OTAA	0	OTAA	Class A Class B	[edit] [delete]
ClassC-ABP	0	ABP	Class A Class C	[edit] [delete]
ClassC-OTAA	0	OTAA	Class A Class C	[edit] [delete]
ClassCB-ABP	0	ABP	Class A Class B Class C	[edit] [delete]
ClassCB-OTAA	0	OTAA	Class A Class B Class C	[edit] [delete]

Figure 3-2-2-9

Device Profiles

Name:

Max TXPower:

Join Type:

Class Type: Class A Class B Class C

Advanced:

Figure 3-2-2-10

Device Profiles Settings	
Item	Description
Name	Enter the name of the device profile.
Max TXPower	Enter the maximum transmit power. The TXPower indicates power levels relative to the Max EIRP level of the end-device. 0 means using the max EIRP. EIRP refers to the Equivalent Isotropically Radiated Power.
Join Type	Select from: "OTAA" and "ABP".
Class Type	Class A is fixed as enabled. Users can check the box of Class B or Class C to add the class type. Note: Beacon period should be set to nonzero value in Packet Forwarder > Advanced if using Class B.

Table 3-2-2-8 Device Profiles Setting Parameters

Advanced	<input checked="" type="checkbox"/>	
MAC Version	<input type="text" value="1.0.2"/>	▼
Regional Parameters Revision	<input type="text" value="B"/>	▼
RX1 Datarate Offset	<input type="text" value="0"/>	▼
RX2 Datarate	<input type="text" value="DR0 (SF12, 125 kHz)"/>	▼
RX2 Channel Frequency	<input type="text" value="505300000"/>	Hz
Frequency List	<input type="text"/>	Hz
Device Channel	<input type="text"/>	

Figure 3-2-2-11

Device Profile Advanced Settings		
Item	Description	Default
MAC Version	Choose the version of the LoRaWAN [®] supported by the end-device.	1.0.2
Regional Parameter Revision	Revision of the Regional Parameters document supported by the end-device.	B
RX1 Datarate Offset	The offset which used for calculating the RX1 data-rate, based on the uplink data-rate.	Based on what is specified in the LoRaWAN [®] regional parameters document
RX2 Datarate	Enter the RX2 datarate which used for the RX2 receive-window.	
RX2 Channel Frequency	RX2 channel frequency which used for the RX2 receive-window.	
Frequency List	List of factory-preset frequencies. The range is based on what is specified in the LoRaWAN [®] regional parameters document.	Null
Device Channel	Change this device frequency channel by typing the channel indexes. When configured, it takes precedence over the global channel. This setting only works for CN470/US915/AU915 gateway.	Null
PingSlot Period	Period of opening the pingslot.	Every Second
PingSlot DataRate	Datarate of the node receiving downlinks.	Based on the supported frequency
PingSlot Freq	Frequency of the node receiving downlinks.	Based on the supported frequency
ACK Timeout	The time for confirmed downlink transmissions. This option is only applicable to class B and class	Class B: 10 Class C: 10

	C.	
--	----	--

Table 3-2-2-9 Device Profiles Advanced Setting Parameters

3.2.2.5 Device

A device is the end-device connecting to, and communicating over the LoRaWAN® network.

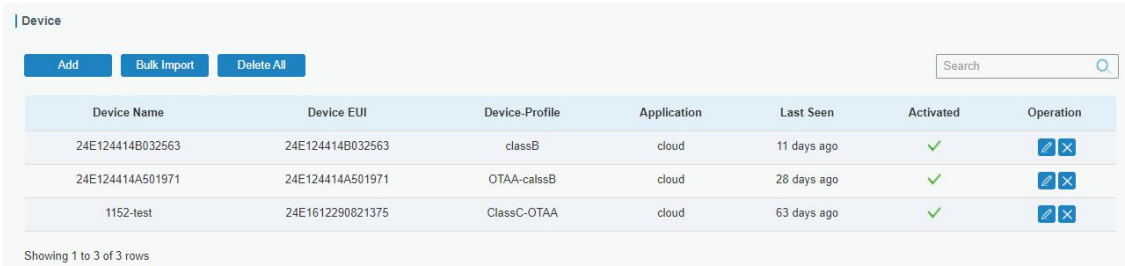

The screenshot shows a web interface for device management. At the top, there are buttons for 'Add', 'Bulk Import', and 'Delete All', along with a search bar. Below is a table with the following data:

Device Name	Device EUI	Device-Profile	Application	Last Seen	Activated	Operation
24E124414B032563	24E124414B032563	classB	cloud	11 days ago	✓	
24E124414A501971	24E124414A501971	OTAA-callsB	cloud	28 days ago	✓	
1152-test	24E1612290821375	ClassC-OTAA	cloud	63 days ago	✓	

Showing 1 to 3 of 3 rows

Figure 3-2-2-12

Item	Description
Add	Add a device.
Bulk Import	Download template and import multiple devices.
Delete All	Delete all devices in the list.
Device Name	Show the name of the device.
Device EUI	Show the EUI of the device.
Device-Profile	Show the name of the device's device profile.
Application	Show the name of the device's application.
Last Seen	Show the time of last packet received.
Activated	Show the status of the device . means that the device has been activated.
Operation	Edit or delete the device.

Table 3-2-2-10 Device Parameters

Device Name	lora-sensor
Description	a short description of your node
Device EUI	24e1641194784358
Device-Profile	ClassC-OTAA
Application	cloud
Payload Codec	
fPort	1
Modbus RTU Data Transmission	Modbus RTU over TCP
Modbus RTU Fport	
TCP Port	
Frame-counter Validation	<input type="checkbox"/>
Application Key	
Device Address	
Network Session Key	
Application Session Key	
Uplink Frame-counter	0
Downlink Frame-counter	0

Figure 3-2-2-13

Device Configuration	
Item	Description
Device Name	Enter the name of this device.
Description	Enter the description of this device.
Device EUI	Enter the EUI of this device.
Device-Profile	Choose the device profile.
Application	Choose the application profile.
Payload Codec	Choose the payload codec existed on Payload Codec page.
fPort	Enter the downlink port of device, it's 85 by default for Milesight devices.
Modbus RTU Data Transmission	Choose from: "Disable", "Modbus RTU to TCP", "Modbus RTU over TCP". This feature is only applicable to Milesight LoRaWAN[®] controllers.(UC501/UC300, etc.) Modbus RTU to TCP: TCP client can send Modbus TCP commands to ask for controller Modbus data. Modbus RTU over TCP: TCP client can send Modbus RTU commands to ask for controller Modbus data.
Modbus RTU Fport	Enter the LoRaWAN [®] frame port for transparent transmission between Milesight LoRaWAN [®] controllers and UG67.

	<p>Range: 2-84, 86-223.</p> <p>Note: this value must be the same as the Milesight LoRaWAN[®] controller's Fport.</p>
TCP Port	Enter the TCP port for data transmission between the TCP Client and UG67 (as TCP Server). Range: 1-65535.
Frame-Counter Validation	If disable the frame-counter validation, it will compromise security as it enables people to perform replay-attacks.
Application Key	Whenever an end-device joins a network via over-the-air activation, the application key is used for derive the Application Session key.
Device Address	The device address identifies the end-device within the current network.
Network Session Key	The network session key specific for the end-device. It is used by the end-device to calculate the MIC or part of the MIC (message integrity code) of all uplink data messages to ensure data integrity.
Application Session Key	The AppSKey is an application session key specific for the end-device. It is used by both the application server and the end-device to encrypt and decrypt the payload field of application-specific data messages.
Uplink Frame-counter	The number of data frames which sent uplink to the network server. It will be incremented by the end-device and received by the end-device. Users can reset the a personalized end-device manually, then the frame counters on the end-device and the frame counters on the network server for that end-device will be reset to 0.
Downlink Frame-counter	The number of data frames which received by the end-device downlink from the network server. It will be incremented by the network server. Users can reset the a personalized end-device manually, then the frame counters on the end-device and the frame counters on the network server for that end-device will be reset to 0.

Table 3-2-2-11 Device Setting Parameters

Related Configuration Example

[Device configuration](#)

3.2.2.6 Multicast Groups

Milesight gateways support for creating Class B or Class C multicast groups to send downlink messages to a group of end devices. A multicast group is a virtual ABP device (i.e. shared session keys), does not support uplink, confirmed downlink nor MAC commands.

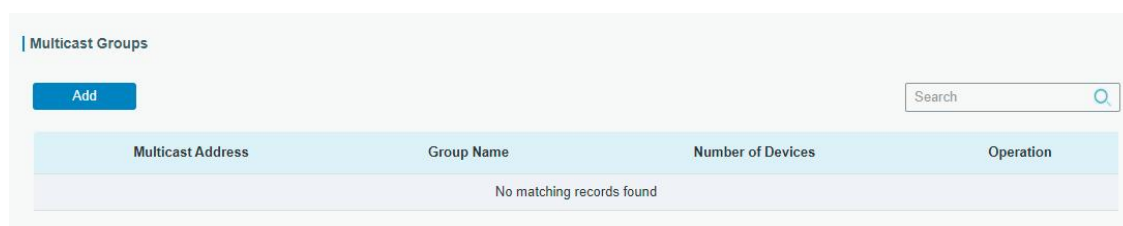

Figure 3-2-2-14

Item	Description
Add	Add a multicast group.
Group Name	Show the name of the group.
Number of Devices	Show the device number of the group.
Operation	Edit or delete the multicast group.

Table 3-2-2-12 Multicast Group Parameters

Group Name	<input type="text"/>
Multicast Address	<input type="text"/>
Multicast Network Session Key	<input type="text"/>
Multicast Application Session Key	<input type="text"/>
Class Type	Class C <input type="button" value="v"/>
Datarate	DR8(SF12,500KHz) <input type="button" value="v"/>
Frequency	923300000 <input type="button" value="v"/> Hz
Frame-counter	0 <input type="button" value="v"/>
Selected Devices	
<input type="text"/>	
Add Device	<input type="text"/>

Figure 3-2-2-15

Multicast Group Configuration	
Item	Description
Group Name	Enter the name of this multicast group.
Multicast Address	Device address (Dev Addr) of all devices in this group.
Multicast Network Session Key	The network session key (Netwks Key) of all devices in this group.
Multicast Application Session Key	The application session key(AppSKey) of all devices in this group.
Class Type	Class B and Class C are optional.
Datarate	Datarate of the node receiving downlinks
Frequency	Downlink frequency of all devices in this group.
Frame-counter	The number of data frames which received by the end-device downlink from the network server. It will be incremented by the network server.

Ping Slot Periodicity	Period of opening the pingslot. This is only applied to Class B end devices.
Selected Devices	Show all device names in this group.
Add Device	Add devices in the pull-down list.

Table 3-2-2-13 Multicast Group Setting Parameters

3.2.2.7 Gateway Fleet

Milesight gateways can connect to UG67 network server. It is suggested to add not more than 5 gateways.

Gateway ID	Name	Status	Last Seen	Operation
24E124FFFEF12263	Local Gateway	Connected	2021-04-19 16:12:27	

Figure 3-2-2-16

Item	Description
Gateway ID	Show the gateway ID.
Name	Show the name of the gateway.
Status	Show the connection status of the gateway.
Last Seen	Show the time of last packet received.
Operation	Edit or delete the gateway.

Table 3-2-2-14 Gateway Fleet Parameters

Figure 3-2-2-17

Item	Description
Gateway ID	Enter the unique gateway ID to recognize the gateway.
Name	Enter the name of this gateway.
Location	GPS data of the gateway can be edited here. If gateway sends GPS data it will replace your customized data.

Table 3-2-2-15 Gateway Setting Parameters

3.2.2.8 Packets

Send Data To Device

Device EUI	Type	Payload	Port	Confirmed	
<input type="text" value="0000000000000000"/>	ASCII ▾	<input type="text"/>	<input type="text" value="85"/>	<input type="checkbox"/>	<input type="button" value="Send"/>

Send Data to Multicast Group

Multicast Group	Type	Payload	Port	
<input type="text"/>	ASCII ▾	<input type="text"/>	<input type="text" value="85"/>	<input type="button" value="Send"/>

Network Server

Device EUI/Group	Gateway ID	Frequency	Datarate	RSSI/SNR	Size	Fcnt	Type	Time	Details
No matching records found									

Figure 3-2-2-18

Send Data To Device/Multicast Group	
Item	Description
Device EUI	Enter the EUI of the device to receive the payload.
Multicast Group	Select the multicast group to send downlinks. Multicast groups can be added under Multicast Groups tab.
Type	Choose the payload type to enter in the payload Input box: ASCII, Hex, base64.
Payload	Enter the message to be sent to this device.
Port	Enter the LoRaWAN [®] frame port for packet transmission between device and Network Server.
Confirmed	After enabled, the end device will receive downlink packet and should answer "confirmed" to the network server. Multicast feature does not support confirmed downlink.

Table 3-2-2-16 Send Data to Device Parameters

Network Server	
Item	Description
Device EUI/Group	Show the EUI of the device or multicast group.
Frequency	Show the used frequency to transmit packets.
Datarate	Show the used datarate to transmit packets.
SNR	Show the signal-noise ratio.
RSSI	Show the received signal strength indicator.
Size	Show the size of payload.
Fcnt	Show the frame counter.
Type	Show the type of the packet:

	<p>JnAcc - Join Accept Packet</p> <p>JnReq - Join Request Packet</p> <p>UpUnc - Uplink Unconfirmed Packet</p> <p>UpCnf - Uplink Confirmed Packet - ACK response from network requested</p> <p>DnUnc - Downlink Unconfirmed Packet</p> <p>DnCnf - Downlink Confirmed Packet- ACK response from end-device requested</p>
Time	Show the time of packet was sent or received.

Table 3-2-2-17 Packet Parameters

Click  to get more details about the packet. As shown:

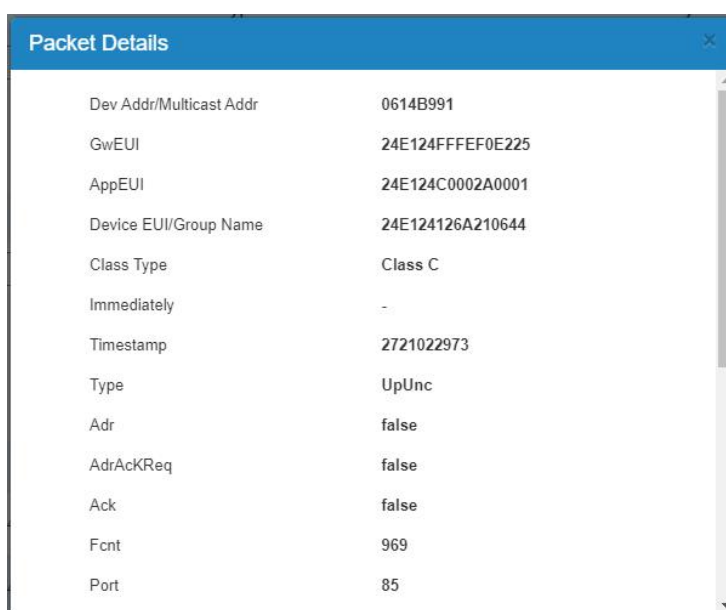

Packet Details	
Dev Addr/Multicast Addr	0614B991
GwEUI	24E124FFFEF0E225
AppEUI	24E124C0002A0001
Device EUI/Group Name	24E124126A210644
Class Type	Class C
Immediately	-
Timestamp	2721022973
Type	UpUnc
Adr	false
AdrAckReq	false
Ack	false
Fcnt	969
Port	85

Figure 3-2-2-19

Item	Description
Dev Addr/Multicast Addr	Show the address of the device/multicast group.
GwEUI	Show the EUI of the gateway.
AppEUI	Show the EUI of the application.
DevEUI/Group Name	Show the EUI of the device/multicast group name.
Class Type	Show the class type of the device or multicast group.
Immediately	True: Device may transmit an explicit (possibly empty) acknowledgement data message immediately after the reception of a data message requiring a confirmation.
Timestamp	Show the timestamp of this packet.
Type	Show the type of the packet: JnAcc - Join Accept Packet

	<p>JnReq - Join Request Packet</p> <p>UpUnc - Uplink Unconfirmed Packet</p> <p>UpCnf - Uplink Confirmed Packet - ACK response from network requested</p> <p>DnUnc - Downlink Unconfirmed Packet</p> <p>DnCnf - Downlink Confirmed Packet- ACK response from end-device requested</p>
Adr	<p>True: The end-node has enabled ADR.</p> <p>False: The end-node has not enabled ADR.</p>
AdrAckReq	<p>In order to validate that the network is receiving the uplink messages, nodes periodically transmit ADRACKReq message. This is 1 bit long.</p> <p>True: Network should respond in ADR_ACK_DELAY time to confirm that it is receiving the uplink messages.</p> <p>False: ADR is disabled or Network does not respond in ADR_ACK_DELAY.</p>
Ack	<p>True: This frame is ACK.</p> <p>False: This frame is not ACK.</p>
Fcnt	<p>Show the frame-counter of this packet. The network server tracks the uplink frame counter and generates the downlink counter for each end-device.</p>
FPort	<p>FPort is a multiplexing port field. If the frame payload field is not empty, the port field must be present. If present, a FPort 16 value of 0 indicates that the FRMPayload contains MAC commands only. When this is the case, the FOptsLen field must be zero. FOptsLen is the length of the FOpts field in bytes.</p>
Modulation	<p>LoRa means the physical layer uses the LoRa modulation.</p>
Bandwidth	<p>Show the bandwidth of this channel.</p>
SpreadFactor	<p>Show the spreadFactor of this channel.</p>
Bitrate	<p>Show the bitrate of this channel.</p>
CodeRate	<p>Show the coderate of this channel.</p>
SNR	<p>Show the SNR of this channel.</p>
RSSI	<p>Show the RSSI of this channel.</p>
Power	<p>Show the transmit power of the device.</p>
Payload (b64)	<p>Show the application payload of this packet.</p>
Payload (hex)	<p>Show the application payload of this packet.</p>
Json	<p>Show the data after decoded.</p>
MIC	<p>Show the MIC of this packet. MIC is a cryptographic message integrity code, computed over the fields MHDR, FHDR, FPort and the encrypted FRMPayload.</p>

Table 3-2-2-18 Packets Details Parameters

Related Topic

[Send Data to Device](#)

3.3 Protocol Integration

3.3.1 BACnet Server

UG67 can work as LoRaWAN to BACnet gateway to integrate with BMS system easily.

3.3.1.1 Server

Server	
Enable	<input checked="" type="checkbox"/>
UDP Port	<input type="text" value="47808"/>
Device ID	<input type="text" value="40185"/>
Device Name	<input type="text" value="UG67-6222B4620088"/>
BBMD	<input checked="" type="checkbox"/>
IP Address	<input type="text"/>
IP Port	<input type="text" value="47808"/>
Time TO Live	<input type="text" value="60000"/> s

Figure 3-3-1-1

Server Settings	
Item	Description
Enable	Enable or disable BACnet server function.
UDP Port	Set communication port of BACnet/IP. Range: 1-65535. The default port is 47808.
Device ID	The unique BACnet device identifier which needs to avoid conflict with other devices.
Device Name	The device name to represent the device.
BBMD	Enable BBMD(BACnet/IP Broadcast Management Device) if BACnet devices of different network subnets should work together.
IP Address	Fill in the IP address of BBMD device or external device registrar.
IP Port	Fill in the UDP/IP port for external device registration.
Time TO Live	Number of seconds used on external device registration.

Table 3-3-1-1 Server Parameters

3.3.1.2 BACnet Object

Object Name	Object Type	Object Instance Nr	Present Value	Units	Updates	Update time	COV	Operation
24E124592B322496.button_...	Analog-Input	0	1670892748800.0	no-units	539	2022-12-13 08:52:06	Disabled	

Showing 1 to 1 of 1 rows

Figure 3-3-1-2

Item	Description
Add	Add a BACnet object. The gateway supports adding 2000 objects at most.
Bulk Import	Download template and import multiple BACnet objects.
Bulk Export	Export all generated BACnet object settings.
Delete All	Delete all objects in the list.
Object Name	Show the name of the BACnet object.
Object Type	Show the type of this object.
Object Instance Nr	Show the instance number of this object.
Present Value	Show the latest value of object.
Units	Show the unit of this object value.
Updates	Show the update times of this object value.
Update time	Show the time for this object to get and update the data.
COV	Show if COV (Change of value) is enabled.
Operation	Edit or delete the object.

Table 3-3-1-2 BACnet Object List Parameters

BACnet Object

Device Name: 24E124592B322496

LoRa Object: button_1_ts

Object Name: 24E124592B322496.button_1_1

Object Type: Analog-Input

Units:

Description:

COV:

COV Increment: 1.0

Figure 3-3-1-3

BACnet Object Configuration	
Item	Description
Device Name	Select the device added on Network Server > Device page.

LoRa Object	Select one of device variables as an object.
Object Name	Customize an unique name for this object.
Object Type	Select the object type as binary input/output/value or analog input/output/value.
Unit	Select the unit of this object value.
Description	Enter the description of this object.
COV	When object value changes, the BACnet server (gateway) will send notification of new value to BACnet client. This only applies to analog type objects.
COV Increment	Only when the object value reaches or over this increment, the BACnet server (gateway) will send the notification.
Polarity	Define the binary input/output status as Normal or Reverse.
Active Text	Characterize the intended effect of active state of binary type object value. Example: when a button is pressed and binary input is 1, active text can be defined as "Pressed".
Inactive Text	Characterize the intended effect of inactive state of binary type object value. Example: for a button, inactive text can be defined as "Unpressed".
Relinquish Default	If there is no command, the analog output or binary output will be set as this relinquish default value.

Table 3-3-1-3 BACnet Object Configuration Parameters

3.4 Network

3.4.1 Interface

3.4.1.1 Port

The Ethernet port can be connected with Ethernet cable to get Internet access. It supports 3 connection types.

- **Static IP:** configure IP address, netmask and gateway for Ethernet WAN interface.
- **DHCP Client:** configure Ethernet WAN interface as DHCP Client to obtain IP address automatically.
- **PPPoE:** configure Ethernet WAN interface as PPPoE Client.

— Port_1

Port	eth 0 ▼
Connection Type	Static IP ▼
IP Address	192.168.23.150
Netmask	255.255.255.0
Gateway	192.168.23.1
MTU	1500
Primary DNS Server	8.8.8.8
Secondary DNS Server	223.5.5.5
Enable NAT	<input checked="" type="checkbox"/>

Figure 3-4-1-1

Port Setting		
Item	Description	Default
Port	The port that is fixed as eth0 port and enabled.	eth 0
Connection Type	Select from "Static IP", "DHCP Client" and "PPPoE".	Static IP
MTU	Set the maximum transmission unit.	1500
Primary DNS Server	Set the primary DNS.	8.8.8.8
Secondary DNS Server	Set the secondary DNS.	223.5.5.5
Enable NAT	Enable or disable NAT function. When enabled, a private IP can be translated to a public IP.	Enable

Table 3-4-1-1 Port Parameters

Related Configuration Example

[Ethernet Connection](#)

1. Static IP Configuration

If the external network assigns a fixed IP for the Ethernet port, user can select "Static IP" mode.

Port_1

Port: eth 0

Connection Type: Static IP

IP Address: 192.168.23.150

Netmask: 255.255.255.0

Gateway: 192.168.23.1

MTU: 1500

Primary DNS Server: 8.8.8.8

Secondary DNS Server: 223.5.5.5

Enable NAT:

Multiple IP Address

IP Address	Netmask	Operation
		<input type="button" value="+"/>

Figure 3-4-1-2

Static IP		
Item	Description	Default
IP Address	Set the IP address which can access Internet.	192.168.23.150
Netmask	Set the Netmask for Ethernet port.	255.255.255.0
Gateway	Set the gateway's IP address for Ethernet port.	192.168.23.1
Multiple IP Address	Set the multiple IP addresses for Ethernet port.	Null

Table 3-4-1-2 Static IP Parameters

2. DHCP Client

If the external network has DHCP server enabled and has assigned IP addresses to the Ethernet WAN interface, user can select "DHCP client" mode to obtain IP address automatically.

Port_1

Port: eth 0

Connection Type: DHCP Client

MTU: 1500

Use Peer DNS:

Primary DNS Server: 8.8.8.8

Secondary DNS Server: 223.5.5.5

Enable NAT:

Figure 3-4-1-3

DHCP Client

Item	Description
Use Peer DNS	Obtain peer DNS automatically during PPP dialing. DNS is necessary when user visits domain name.

Table 3-4-1-3 DHCP Client Parameters

3. PPPoE

PPPoE refers to a point to point protocol over Ethernet. User has to install a PPPoE client on the basis of original connection way. With PPPoE, remote access devices can get control of each user.

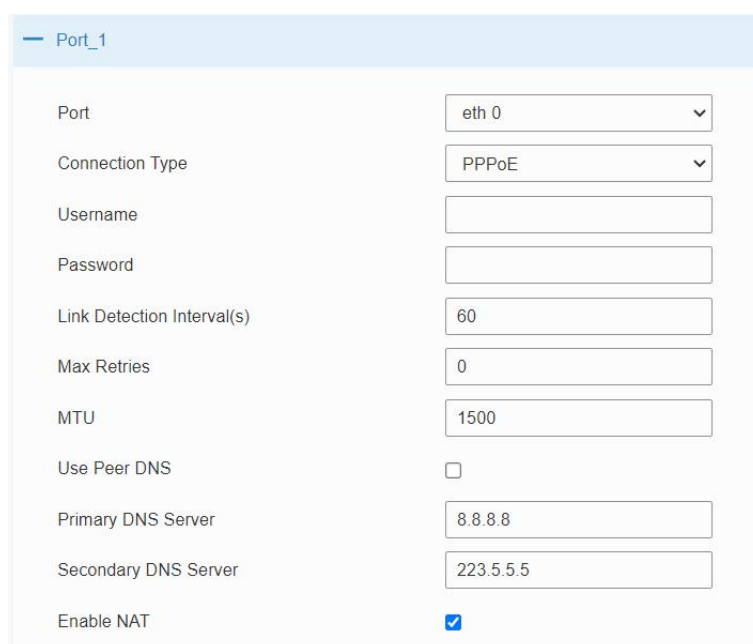

Port_1

Port: eth 0

Connection Type: PPPoE

Username:

Password:

Link Detection Interval(s): 60

Max Retries: 0

MTU: 1500

Use Peer DNS:

Primary DNS Server: 8.8.8.8

Secondary DNS Server: 223.5.5.5

Enable NAT:

Figure 3-4-1-4

PPPoE	
Item	Description
Username	Enter the username provided by your Internet Service Provider (ISP).
Password	Enter the password provided by your Internet Service Provider (ISP).
Link Detection Interval (s)	Set the heartbeat interval for link detection. Range: 1-600.
Max Retries	Set the maximum retry times after it fails to dial up. Range: 0-9.
Use Peer DNS	Obtain peer DNS automatically during PPP dialing. DNS is necessary when user visits domain name.

Table 3-4-1-4 PPPOE Parameters

3.4.1.2 WLAN

This section explains how to set the related parameters for Wi-Fi network. UG67 supports 802.11 b/g/n, as AP or client mode.

Port	WLAN	Cellular	Loopback
WLAN			
Enable	<input checked="" type="checkbox"/>		
Work Mode	AP		
SSID Broadcast	<input checked="" type="checkbox"/>		
AP Isolation	<input type="checkbox"/>		
Radio Type	802.11n(2.4GHz)		
Channel	Auto		
SSID			
BSSID			
Encryption Mode	No Encryption		
Bandwidth	20MHz		
Max Client Number	10		
IP Setting			
Protocol	Static IP		
IP Address			
	DHCP Settings		
Netmask			

Figure 3-4-1-5

WLAN	
Enable	<input checked="" type="checkbox"/>
Work Mode	Client Scan
SSID	
BSSID	
Encryption Mode	WPA-PSK/WPA2-PSK
Cipher	Auto
Key	
IP Setting	
Protocol	Static IP
IP Address	
Netmask	255.255.255.0
Gateway	

Figure 3-4-1-6

WLAN Settings	
Item	Description
Enable	Enable/disable WLAN.

Work Mode	Select gateway's work mode. The options are "Client" or "AP".
BSSID	Fill in the MAC address of the access point. Either SSID or BSSID can be filled to join the network.
SSID	Fill in the SSID of the access point.
Client Mode	
Scan	Click "Scan" button to search the nearby access point.
Encryption Mode	Select encryption mode. The options are "No Encryption", "WEP Open System", "WEP Shared Key", "WPA-PSK", "WPA2-PSK", "WPA-PSK/WPA2-PSK", "WPA-Enterprise", "WPA2-Enterprise" and "WPA-Enterprise/WPA2-Enterprise".
Cipher	Select cipher. The options are "Auto", "AES", "TKIP" and "AES/TKIP".
Key	Fill the pre-shared key of WEP/WPA encryption.
XSupplicant Type	Select from "Peap", "Leap", "TLS" and "TTLS".
User	Fill the user of WPA/WPA2-Enterprise.
Anonymous Identity	Fill the anonymous identity of WPA/WPA2-Enterprise.
Phase2	Fill the phase2 of WPA/WPA2-Enterprise.
Public Server Certificate	The public server certificate used for verifying with WPA/WPA2-Enterprise access point.
AP Mode	
SSID Broadcast	When SSID broadcast is disabled, other wireless devices can't not find the SSID, and users have to enter the SSID manually to access to the wireless network.
AP Isolation	When AP isolation is enabled, all users which access to the AP are isolated without communication with each other.
Radio Type	Select Radio type. The options are "802.11b (2.4 GHz)", "802.11g (2.4 GHz)", "802.11n (2.4 GHz)".
Channel	Select wireless channel. The options are "Auto", "1", "2"....."11".
Encryption Mode	Select encryption mode. The options are "No Encryption", "WEP Open System", "WEP Shared Key", "WPA-PSK", "WPA2-PSK" and "WPA-PSK/WPA2-PSK".
Cipher	Select cipher. The options are "Auto", "AES", "TKIP" and "AES/TKIP".
Key	Fill the pre-shared key of WPA encryption.
Bandwidth	Select bandwidth. The options are "20MHz" and "40MHz".
Max Client Number	Set the maximum number of client to access when the gateway is configured as AP.
IP Setting	
Protocol	Set the protocol in wireless network.
IP Address	Set the IP address in wireless network.
Netmask	Set the netmask in wireless network.
Gateway	Set the gateway in wireless network.

Table 3-4-1-5 WLAN Parameters

Port	WLAN	Cellular	Loopback					
< GoBack								
SSID	Channel	Signal	Cipher	BSSID	Security	Frequency		
Vison Sensor_006602	Auto	-94dBm	Auto	24:e1:24:00:66:02	No Encryption	2462MHz	Join Network	
Milesight_Test	Auto	-88dBm	AES	ec:26:ca:99:3a:a4	WPA-PSK/WPA2-PSK	2437MHz	Join Network	

Figure 3-4-1-7

Client Mode-Scan	
SSID	Show SSID.
Channel	Show wireless channel.
Signal	Show wireless signal.
BSSID	Show the MAC address of the access point.
Security	Show the encryption mode.
Frequency	Show the frequency of radio.
Join Network	Click the button to join the wireless network.

Table 3-4-1-6 WLAN Scan Parameters

Related Topic

[Wi-Fi Application Example](#)

3.4.1.3 Cellular (Cellular Version Only)

This section explains how to set the related parameters for cellular network.

Cellular Setting

Enable

Network Type

APN

Username

Password

Access Number

PIN Code

Authentication Type

Roaming

Customize MTU

MTU

Enable IMS

SMS Center

Figure 3-4-1-8

Connection Setting

Enable NAT

Restart When Dial-up failed

ICMP Server

Secondary ICMP Server

ICMP Detection Max Retries

ICMP Detection Timeout s

ICMP Detection Interval s

SMS Settings

SMS Mode

Figure 3-4-1-9

General Settings	
Item	Description
Enable	Check the option to enable cellular feature.
Network Type	Select from "Auto", "Auto 3G/4G", "4G Only" and "3G Only". Auto: connect to the network with the strongest signal automatically. 4G Only: connect to 4G network only. And so on.
APN	Enter the Access Point Name for cellular dial-up connection provided by

	local ISP.
Username	Enter the username for cellular dial-up connection provided by local ISP.
Password	Enter the password for cellular dial-up connection provided by local ISP.
Access Number	Enter the dial-up center NO. For cellular dial-up connection provided by local ISP.
PIN Code	Enter a 4-8 characters PIN code to unlock the SIM.
Authentication Type	Select from "None", "PAP", "CHAP".
Roaming	Enable or disable roaming.
Customized MTU	Enable or disable to customize the maximum transmission units. When disabled, the device will use operator's MTU settings.
MTU	Set the maximum transmission units. Range: 68-1500.
Enable IMS	Enable or disable IMS function.
SMS Center	Enter the local SMS center number for storing, forwarding, converting and delivering SMS message.
Enable NAT	Enable or disable NAT function.
Restart When Dial-up failed	When this function is enabled, the gateway will restart automatically if the dial-up fails several times.
ICMP Server	Set the ICMP detection server's IP address.
Secondary ICMP Server	Set the secondary ICMP detection server's IP address.
ICMP Detection Max Retries	Set max number of retries when ICMP detection fails.
ICMP Detection Timeout	Set timeout of ICMP detection.
ICMP Detection Interval	Set interval of ICMP detection.
SMS Mode	Select SMS mode from "TEXT" and "PDU".

Table 3-4-1-7 Cellular Parameters

Connection Setting	<input checked="" type="checkbox"/>
Connection Mode	Connect on Demand ▼
Redial Interval(s)	5
Max Idle Time(s)	60
Triggered by Call	<input type="checkbox"/>
Triggered by SMS	<input type="checkbox"/>

Figure 3-4-1-10

Item	Description
Connection Mode	

Connection Mode	Select from "Always Online" and "Connect on Demand".
Redial Interval(s)	Set the time interval between redials. Range: 0-3600.
Max Idle Time(s)	Set the maximum duration of the gateway when current link is under idle status. Range: 10-3600.
Triggered by Call	The gateway will switch from offline mode to cellular network mode automatically when it receives a call from the specific phone number.
Call Group	Select a call group for call trigger. Go to "System > General Settings > Phone" to set up phone group.
Triggered by SMS	The gateway will switch from offline mode to cellular network mode automatically when it receives a specific SMS from the specific mobile phone.
SMS Group	Select a SMS group for trigger. Go to "System > General Settings > Phone" to set up SMS group.
SMS Text	Fill in the SMS content for triggering.

Table 3-4-1-8 Cellular Parameters

Related Topics

[Cellular Connection Application Example](#)

[Phone Group](#)

3.4.1.4 Loopback

Loopback interface is used for replacing gateway's ID as long as it is activated. When the interface is DOWN, the ID of the gateway has to be selected again which leads to long convergence time of OSPF. Therefore, Loopback interface is generally recommended as the ID of the gateway.

Loopback interface is a logic and virtual interface on gateway. Under default conditions, there's no loopback interface on gateway, but it can be created as required.

Figure 3-4-1-11

Loopback		
Item	Description	Default
IP Address	Unalterable	127.0.0.1
Netmask	Unalterable	255.0.0.0



Multiple IP Addresses	Apart from the IP above, user can configure other IP addresses.	Null
-----------------------	---	------

Table 3-4-1-9 Loopback Parameters

3.4.1.5 VLAN Trunk

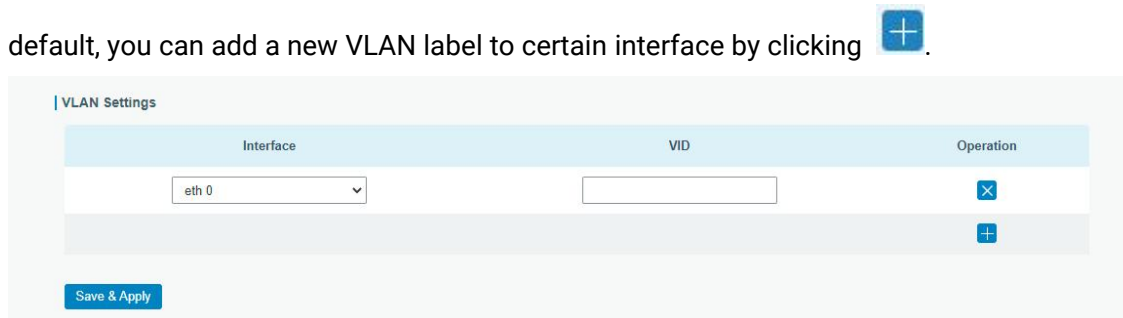
UG67 gateway supports the Ethernet port working as VLAN Trunk client and be assigned a VLAN ID, which easy to traffic classification. When VLAN ID is set, port on **"Network" > "Interface" > "Port"** can be chosen as eth0.x with x being VLAN ID. VLAN Setting is blank by default, you can add a new VLAN label to certain interface by clicking .



Interface	VID	Operation
eth 0		
		

Save & Apply

Figure 3-4-1-12

VLAN Trunk	
Item	Description
Interface	Select the VLAN interface, it's fixed as eth0.
VID	Set the label ID of the VLAN. Range: 1-4094.

Table 3-4-1-10 VLAN Trunk Parameters

3.4.2 Firewall

This section describes how to set the firewall parameters, including website block, ACL, DMZ, Port Mapping and MAC Binding.

The firewall implements corresponding control of data flow at entry direction (from Internet to local area network) and exit direction (from local area network to Internet) according to the content features of packets, such as protocol style, source/destination IP address, etc. It ensures that the gateway operate in a safe environment and host in local area network.

3.4.2.1 Security

The screenshot shows a configuration interface with a top navigation bar containing 'Security', 'ACL', 'DMZ', 'Port Mapping', and 'MAC Binding'. The 'Security' tab is active. Below the navigation bar, there are two sections for website blocking:

- Website Blocking by URL Address:** This section contains a text input field with the value 'http://'. To the right of the input field are two blue buttons: a minus sign (X) and a plus sign (+).
- Website Blocking by Keyword:** This section contains an empty text input field. To the right of the input field are two blue buttons: a minus sign (X) and a plus sign (+).

Figure 3-4-2-1

Website Blocking	
URL Address	Enter the HTTP address which you want to block.
Keyword	You can block specific website by entering keyword. The maximum number of character allowed is 64.

Table 3-2-2-1 Security Parameters

3.4.2.2 ACL

Access control list, also called ACL, implements permission or prohibition of access for specified network traffic (such as the source IP address) by configuring a series of matching rules so as to filter the network interface traffic. When gateway receives packet, the field will be analyzed according to the ACL rule applied to the current interface. After the special packet is identified, the permission or prohibition of corresponding packet will be implemented according to preset strategy.

The data package matching rules defined by ACL can also be used by other functions requiring flow distinction.

The screenshot displays the ACL configuration page. At the top, there are tabs for Security, ACL (selected), DMZ, Port Mapping, and MAC Binding. Under 'ACL Setting', the 'Default Filter Policy' is set to 'Accept'. The 'Access Control List' section contains several input fields: 'Type' is set to 'extended', 'Action' is 'permit', and 'Protocol' is 'ip'. The 'Source Wildcard Mask' and 'Destination Wildcard Mask' are both set to '0.0.0.0'. There are 'Save' and 'Cancel' buttons at the bottom of this section. Below is the 'Interface List' section, which is a table with columns for 'Interface', 'In ACL', 'Out ACL', and 'Operation'. A plus sign button is located at the bottom right of the table.

Figure 3-4-2-2

Item	Description
ACL Setting	
Default Filter Policy	Select from "Accept" and "Deny". The packets which are not included in the access control list will be processed by the default filter policy.
Access Control List	
Type	Select type from "Extended" and "Standard".
ID	User-defined ACL number. Range: 1-199.
Action	Select from "Permit" and "Deny".
Protocol	Select protocol from "ip", "icmp", "tcp", "udp", and "1-255".
Source IP	Source network address (leaving it blank means all).
Source Wildcard Mask	Wildcard mask of the source network address.
Destination IP	Destination network address (0.0.0.0 means all).
Destination Wildcard Mask	Wildcard mask of destination address.
Description	Fill in a description for the groups with the same ID.
ICMP Type	Enter the type of ICMP packet. Range: 0-255.
ICMP Code	Enter the code of ICMP packet. Range: 0-255.
Source Port Type	Select source port type, such as specified port, port range, etc.
Source Port	Set source port number. Range: 1-65535.
Start Source Port	Set start source port number. Range: 1-65535.
End Source Port	Set end source port number. Range: 1-65535.

Destination Port Type	Select destination port type, such as specified port, port range, etc.
Destination Port	Set destination port number. Range: 1-65535.
Start Destination Port	Set start destination port number. Range: 1-65535.
End Destination Port	Set end destination port number. Range: 1-65535.
More Details	Show information of the port.
Interface List	
Interface	Select network interface for access control.
In ACL	Select a rule for incoming traffic from ACL ID.
Out ACL	Select a rule for outgoing traffic from ACL ID.

Table 3-4-2-2 ACL Parameters

3.4.2.3 DMZ

DMZ is a host within the internal network that has all ports exposed, except those forwarded ports in port mapping.

Figure 3-4-2-3

DMZ	
Item	Description
Enable	Enable or disable DMZ.
DMZ Host	Enter the IP address of the DMZ host on the internal network.
Source Address	Set the source IP address which can access to DMZ host. "0.0.0.0/0" means any address.

Table 3-4-2-3 DMZ Parameters

3.4.2.4 Port Mapping (DNAT)

When external services are needed internally (for example, when a website is published externally), the external address initiates an active connection. And, the router or the gateway on the firewall receives the connection. Then it will convert the connection into the an internal connection. This conversion is called DNAT, which is mainly used for external and interval services.

Click  to add a new port mapping rules.

Figure 3-4-2-4

Port Mapping	
Item	Description
Source IP	Specify the host or network which can access local IP address. 0.0.0.0/0 means all.
Source Port	Enter the TCP or UDP port from which incoming packets are forwarded. Range: 1-65535.
Destination IP	Enter the IP address that packets are forwarded to after being received on the incoming interface.
Destination Port	Enter the TCP or UDP port that packets are forwarded to after being received on the incoming port(s). Range: 1-65535.
Protocol	Select from "TCP" and "UDP" as your application required.
Description	The description of this rule.

Table 3-4-2-4 Port Mapping Parameters

Related Configuration Example

[NAT Application Example](#)

3.4.2.5 MAC Binding

MAC Binding is used for specifying hosts by matching MAC addresses and IP addresses that are in the list of allowed outer network access.

Figure 3-4-2-5

MAC Binding List	
Item	Description
MAC Address	Set the binding MAC address.

IP Address	Set the binding IP address.
Description	Fill in a description for convenience of recording the meaning of the binding rule for each piece of MAC-IP.

Table 3-4-2-5 MAC Binding Parameters

3.4.3 DHCP

UG67 can be set as a DHCP server to distribute IP address when Wi-Fi work as AP mode.

Figure 3-4-3-1

DHCP Server		
Item	Description	Default
Enable	Enable or disable DHCP server.	Enable
Interface	Only wlan interface is allowed to distribute IP addresses.	wlan0
Start Address	Define the beginning of the pool of IP addresses which will be leased to DHCP clients.	192.168.1.100
End Address	Define the end of the pool of IP addresses which will be leased to DHCP clients.	192.168.1.199
Netmask	Define the subnet mask of IP address obtained by DHCP clients from DHCP server.	255.255.255.0
Lease Time (Min)	Set the lease time on which the client can use the IP address obtained from DHCP server. Range: 1-10080.	1440
Primary	Set the primary DNS server.	8.8.8.8

DNS Server		
Secondary DNS Server	Set the secondary DNS server.	Null
Windows Name Server	Define the Windows Internet Naming Service obtained by DHCP clients from DHCP sever. Generally you can leave it blank.	Null
Static IP		
MAC Address	Set a static and specific MAC address for the DHCP client (it should be different from other MACs so as to avoid conflict).	Null
IP Address	Set a static and specific IP address for the DHCP client (it should be outside of the DHCP range).	Null

Table 3-4-3-1 DHCP Server Parameters

3.4.4 DDNS

Dynamic DNS (DDNS) is a method that automatically updates a name server in the Domain Name System, which allows user to alias a dynamic IP address to a static domain name. DDNS serves as a client tool and needs to coordinate with DDNS server. Before starting configuration, user shall register on a website of proper domain name provider and apply for a domain name.

The screenshot shows a web-based configuration page for DDNS. At the top, there is a 'DDNS' header. Below it, a section titled 'DDNS Method List' contains a table with the following columns: Name, Interface, Service Type, Username, User ID, Password, Server, Server Path, Hostname, Append IP, and Operation. The 'Interface' column is set to 'wlan0' and the 'Service Type' column is set to 'DynDI'. There are input fields for 'Username', 'User ID', and 'Password', and a checkbox for 'Append IP'. A blue 'X' icon is visible in the 'Operation' column, and a blue '+' icon is at the bottom right.

Figure 3-4-4-1

DDNS	
Item	Description
Name	Give the DDNS a descriptive name.
Interface	Set interface bundled with the DDNS.
Service Type	Select the DDNS service provider.
Username	Enter the username for DDNS register.
User ID	Enter User ID of the custom DDNS server.
Password	Enter the password for DDNS register.
Server	Enter the name of DDNS server.
Hostname	Enter the hostname for DDNS.
Append IP	Append your current IP to the DDNS server update path.

Table 3-4-4-1 DDNS Parameters

3.4.5 Link Failover

This section describes how to configure link failover strategies, such as VRRP strategies.

Configuration Steps

1. Define one or more SLA operations (ICMP probe).
2. Define one or more track objects to track the status of SLA operation.
3. Define applications associated with track objects, such as VRRP or static routing.

3.4.5.1 SLA

SLA setting is used for configuring link probe method. The default probe type is ICMP.

ID	Type	Destination Address	Secondary Destination Address	Data Size	Interval(s)	Timeout(ms)	Packet Loss Count	Start Time	Operation
1	icmp-echo	8.8.8.8	223.5.5.5	56	15	5000	3	now	X

Figure 3-4-5-1

SLA		
Item	Description	Default
ID	SLA index. Up to 10 SLA settings can be added. Range: 1-10.	1
Type	ICMP-ECHO is the default type to detect if the link is alive.	icmp-echo
Destination Address	The detected IP address.	8.8.8.8
Secondary Destination Address	The secondary detected IP address.	223.5.5.5
Data Size	User-defined data size. Range: 0-1000.	56
Interval (s)	User-defined detection interval. Range: 1-608400.	30
Timeout (ms)	User-defined timeout for response to determine ICMP detection failure. Range: 1-300000.	5000
Packet Loss Count	Define packet loss count in each SLA probe. SLA probe fails when the preset packet loss count is exceeded.	5
Start Time	Detection start time; select from "Now" and blank character. Blank character means this SLA detection doesn't start.	now

Table 3-4-5-1 SLA Parameters

3.4.5.2 Track

Track setting is designed for achieving linkage among SLA module, Track module and Application module. Track setting is located between application module and SLA module

with main function of shielding the differences of various SLA modules and providing unified interfaces for application module.

Linkage between Track Module and SLA module

Once you complete the configuration, the linkage relationship between Track module and SLA module will be established. SLA module is used for detection of link status, network performance and notification of Track module. The detection results help track status change timely.

- For successful detection, the corresponding track item is Positive.
- For failed detection, the corresponding track item is Negative.

Linkage between Track Module and Application Module

After configuration, the linkage relationship between Track module and Application module will be established. When any change occurs in track item, a notification that requires corresponding treatment will be sent to Application module.

Currently, the application modules like VRRP and static routing can get linkage with track module.

If it sends an instant notification to Application module, the communication may be interrupted in some circumstances due to routing's failure like timely restoration or other reasons. Therefore, user can set up a period of time to delay notifying application module when the track item status changes.

ID	Type	SLA ID	Interface	Negative Delay(s)	Positive Delay(s)	Operation
1	sla	1	wlan0	0	1	+

Figure 3-4-5-2

Item	Description	Default
Index	Track index. Up to 10 track settings can be configured. Range: 1-10.	1
Type	The options are "sla" and "interface".	SLA
SLA ID	Defined SLA ID.	1
Interface	Select the interface whose status will be detected.	cellular0
Negative Delay (s)	When interface is down or SLA probing fails, it will wait according to the time set here before actually changing its status to Down. Range: 0-180 (0 refers to immediate switching).	0
Positive Delay (s)	When failure recovery occurs, it will wait according to the time set here before actually changing its status to Up. Range: 0-180 (0 refers to immediate switching).	1

Table 3-4-5-2 Track Parameters

3.4.5.3 WAN Failover

WAN failover refers to failover between Ethernet WAN interface and cellular interface. When service transmission can't be carried out normally due to malfunction of a certain interface or lack of bandwidth, the rate of flow can be switched to backup interface quickly. Then the backup interface will carry out service transmission and share network flow so as to improve reliability of communication of data equipment.

When link state of main interface is switched from up to down, system will have the pre-set delay works instead of switching to link of backup interface immediately. Only if the state of main interface is still down after delay, will the system switch to link of backup interface. Otherwise, system will remain unchanged.

Main Interface	Backup Interface	Startup Delay(s)	Up Delay(s)	Down Delay(s)	Track ID	Operation
Cellular 0	eth 0	30	0	0	1	X
						+

Figure 3-4-5-3

WAN Failover		
Parameters	Description	Default
Main Interface	Select a link interface as the main link.	--
Backup Interface	Select a link interface as the backup link.	--
Startup Delay (s)	Set how long to wait for the startup tracking detection policy to take effect. Range: 0-300.	30
Up Delay (s)	When the primary interface switches from failed detection to successful detection, switching can be delayed based on the set time. Range: 0-180 (0 refers to immediate switching)	0
Down Delay (s)	When the primary interface switches from successful detection to failed detection, switching can be delayed based on the set time. Range: 0-180 (0 refers to immediate switching).	0
Track ID	Track detection, select the defined track ID.	--

Table 3-4-5-3 WAN Failover Parameters

3.4.6 VPN

Virtual Private Networks, also called VPNs, are used to securely connect two private networks together so that devices can connect from one network to the other network via secure channels.

UG67 supports DMVPN, IPsec, GRE, L2TP, PPTP, OpenVPN, as well as GRE over IPsec and L2TP over IPsec.

3.4.6.1 DMVPN

A dynamic multi-point virtual private network (DMVPN), combining mGRE and IPsec, is a secure network that exchanges data between sites without passing traffic through an organization's headquarter VPN server or gateway.

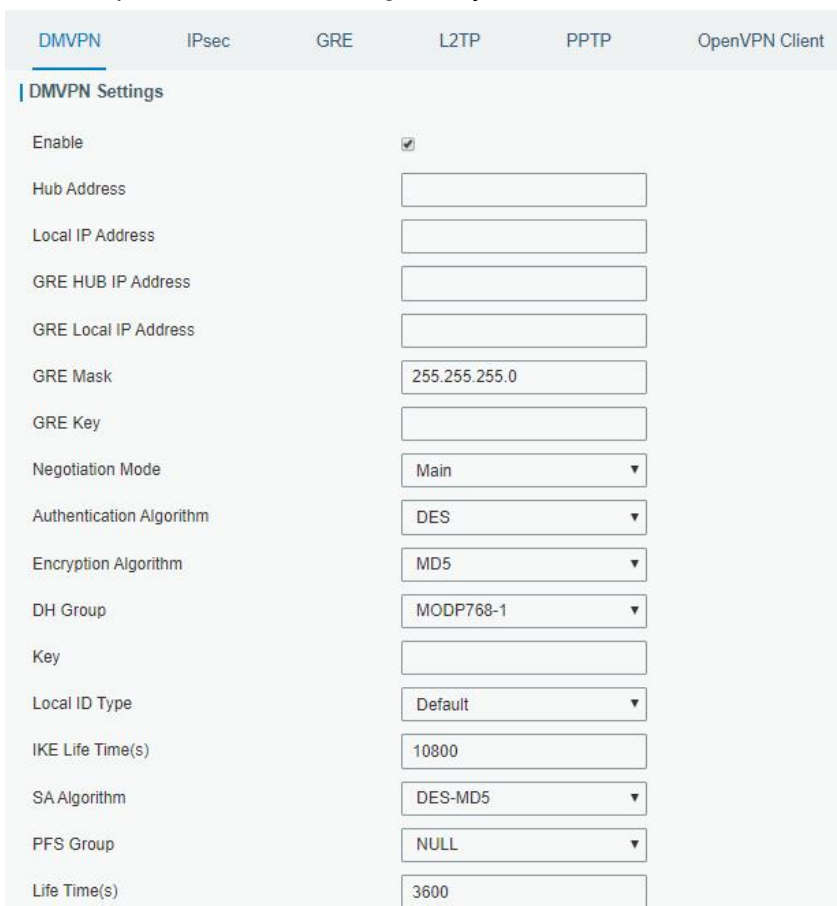

DMVPN	IPsec	GRE	L2TP	PPTP	OpenVPN Client
DMVPN Settings					
Enable		<input checked="" type="checkbox"/>			
Hub Address		<input type="text"/>			
Local IP Address		<input type="text"/>			
GRE HUB IP Address		<input type="text"/>			
GRE Local IP Address		<input type="text"/>			
GRE Mask		<input type="text" value="255.255.255.0"/>			
GRE Key		<input type="text"/>			
Negotiation Mode		<input type="text" value="Main"/>			
Authentication Algorithm		<input type="text" value="DES"/>			
Encryption Algorithm		<input type="text" value="MD5"/>			
DH Group		<input type="text" value="MODP768-1"/>			
Key		<input type="text"/>			
Local ID Type		<input type="text" value="Default"/>			
IKE Life Time(s)		<input type="text" value="10800"/>			
SA Algorithm		<input type="text" value="DES-MD5"/>			
PFS Group		<input type="text" value="NULL"/>			
Life Time(s)		<input type="text" value="3600"/>			

Figure 3-4-6-1



VPN	DPD Time Interval(s)	<input type="text" value="30"/>
System	DPD Timeout(s)	<input type="text" value="150"/>
Industrial	Cisco Secret	<input type="text"/>
	NHRP Holdtime(s)	<input type="text" value="7200"/>

Figure 3-4-6-2

DMVPN	
Item	Description
Enable	Enable or disable DMVPN.
Hub Address	The IP address or domain name of DMVPN Hub.
Local IP address	DMVPN local tunnel IP address.
GRE Hub IP Address	GRE Hub tunnel IP address.
GRE Local IP Address	GRE local tunnel IP address.
GRE Netmask	GRE local tunnel netmask.
GRE Key	GRE tunnel key.

Negotiation Mode	Select from "Main" and "Aggressive".
Authentication Algorithm	Select from "DES", "3DES", "AES128", "AES192" and "AES256".
Encryption Algorithm	Select from "MD5" and "SHA1".
DH Group	Select from "MODP768_1", "MODP1024_2" and "MODP1536_5".
Key	Enter the preshared key.
Local ID Type	Select from "Default", "ID", "FQDN", and "User FQDN"
IKE Life Time (s)	Set the lifetime in IKE negotiation. Range: 60-86400.
SA Algorithm	Select from "DES_MD5", "DES_SHA1", "3DES_MD5", "3DES_SHA1", "AES128_MD5", "AES128_SHA1", "AES192_MD5", "AES192_SHA1", "AES256_MD5" and "AES256_SHA1".
PFS Group	Select from "NULL", "MODP768_1", "MODP1024_2" and "MODP1536-5".
Life Time (s)	Set the lifetime of IPsec SA. Range: 60-86400.
DPD Interval Time (s)	Set DPD interval time
DPD Timeout (s)	Set DPD timeout.
Cisco Secret	Cisco Nhrp key.
NHRP Holdtime (s)	The holdtime of Nhrp protocol.

Table 3-4-6-1 DMVPN Parameters

3.4.6.2 IPsec

IPsec is especially useful for implementing virtual private networks and for remote user access through dial-up connection to private networks. A big advantage of IPsec is that security arrangements can be handled without requiring changes to individual user computers.

IPsec provides three choices of security service: Authentication Header (AH), Encapsulating Security Payload (ESP), and Internet Key Exchange (IKE). AH essentially allows authentication of the senders' data. ESP supports both authentication of the sender and data encryption. IKE is used for cipher code exchange. All of them can protect one and more data flows between hosts, between host and gateway, and between gateways.

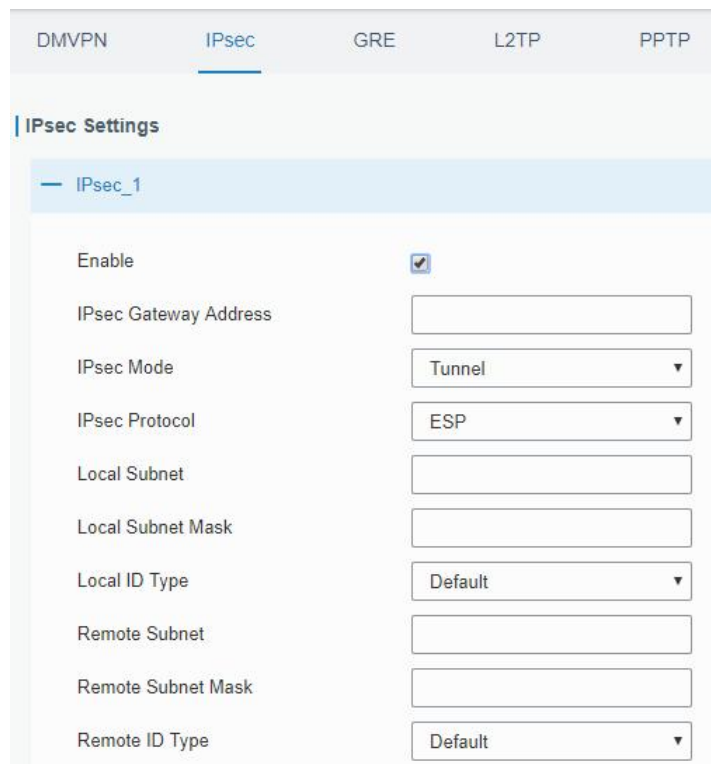

DMVPN IPsec GRE L2TP PPTP

IPsec Settings

IPsec_1

Enable

IPsec Gateway Address

IPsec Mode

IPsec Protocol

Local Subnet

Local Subnet Mask

Local ID Type

Remote Subnet

Remote Subnet Mask

Remote ID Type

Figure 3-4-6-3

IPsec	
Item	Description
Enable	Enable IPsec tunnel. A maximum of 3 tunnels is allowed.
IPsec Gateway Address	Enter the IP address or domain name of remote IPsec server.
IPsec Mode	Select from "Tunnel" and "Transport".
IPsec Protocol	Select from "ESP" and "AH".
Local Subnet	Enter the local subnet IP address that IPsec protects.
Local Subnet Netmask	Enter the local netmask that IPsec protects.
Local ID Type	Select from "Default", "ID", "FQDN", and "User FQDN".
Remote Subnet	Enter the remote subnet IP address that IPsec protects.
Remote Subnet Mask	Enter the remote netmask that IPsec protects.
Remote ID type	Select from "Default", "ID", "FQDN", and "User FQDN".

Table 3-4-6-2 IPsec Parameters

IKE Parameter	<input checked="" type="checkbox"/>
IKE Version	IKEv1
Negotiation Mode	Main
Encryption Algorithm	DES
Authentication Algorithm	MD5
DH Group	MODP768-1
Local Authentication	PSK
Local Secrets	
XAUTH	<input type="checkbox"/>
Lifetime(s)	10800
SA Parameter	<input checked="" type="checkbox"/>
SA Algorithm	DES-MD5
PFS Group	NULL
Lifetime(s)	3600
DPD Time Interval(s)	30
DPD Timeout(s)	150
IPsec Advanced	<input checked="" type="checkbox"/>
Enable Compression	<input type="checkbox"/>
VPN Over IPsec Type	NONE

Figure 3-4-6-4

IKE Parameter	
Item	Description
IKE Version	Select from "IKEv1" and "IKEv2".
Negotiation Mode	Select from "Main" and "Aggressive".
Encryption Algorithm	Select from "DES", "3DES", "AES128", "AES192" and "AES256".
Authentication Algorithm	Select from "MD5" and "SHA1"
DH Group	Select from "MODP768_1", "MODP1024_2" and "MODP1536_5".
Local Authentication	Select from "PSK" and "CA".
Local Secrets	Enter the preshared key.
XAUTH	Enter XAUTH username and password after XAUTH is enabled.
Lifetime (s)	Set the lifetime in IKE negotiation. Range: 60-86400.
SA Parameter	
SA Algorithm	Select from "DES_MD5", "DES_SHA1", "3DES_MD5", "3DES_SHA1", "AES128_MD5", "AES128_SHA1", "AES192_MD5", "AES192_SHA1", "AES256_MD5" and "AES256_SHA1".
PFS Group	Select from "NULL", "MODP768_1", "MODP1024_2" and "MODP1536_5".
Lifetime (s)	Set the lifetime of IPsec SA. Range: 60-86400.

DPD Interval Time(s)	Set DPD interval time to detect if the remote side fails.
DPD Timeout(s)	Set DPD timeout. Range: 10-3600.
IPsec Advanced	
Enable Compression	The head of IP packet will be compressed after it's enabled.
VPN Over IPsec Type	Select from "NONE", "GRE" and "L2TP" to enable VPN over IPsec function.

Table 3-4-6-3 IPsec Parameters

3.4.6.3 GRE

Generic Routing Encapsulation (GRE) is a protocol that encapsulates packets in order to route other protocols over IP networks. It's a tunneling technology that provides a channel through which encapsulated data message can be transmitted and encapsulation and decapsulation can be realized at both ends.

In the following circumstances the GRE tunnel transmission can be applied:

- GRE tunnel can transmit multicast data packets as if it were a true network interface. Single use of IPsec cannot achieve the encryption of multicast.
- A certain protocol adopted cannot be routed.
- A network of different IP addresses shall be required to connect other two similar networks.

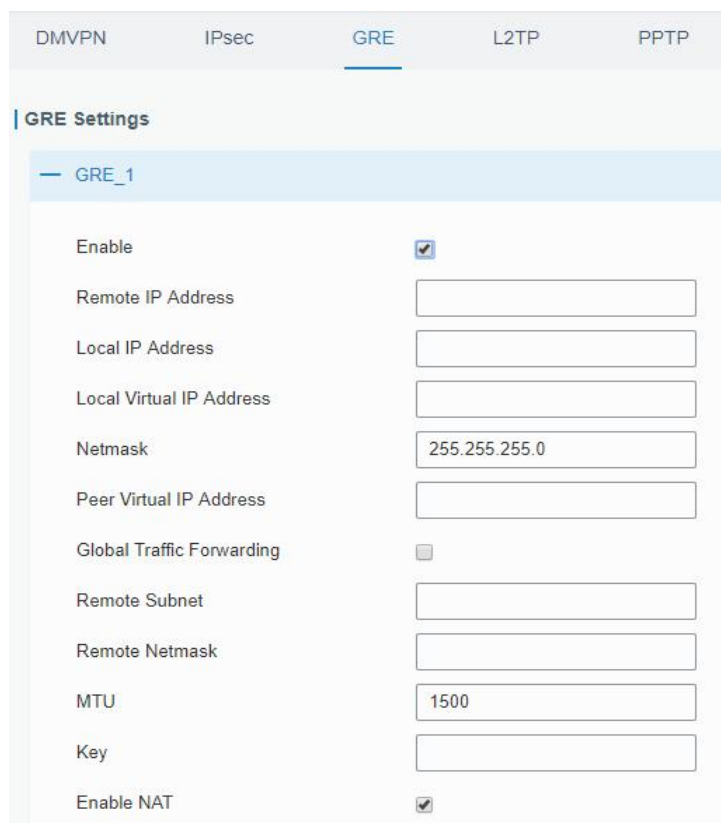

Figure 3-4-6-5

GRE	
Item	Description
Enable	Check to enable GRE function.

Remote IP Address	Enter the real remote IP address of GRE tunnel.
Local IP Address	Set the local IP address.
Local Virtual IP Address	Set the local tunnel IP address of GRE tunnel.
Netmask	Set the local netmask.
Peer Virtual IP Address	Enter remote tunnel IP address of GRE tunnel.
Global Traffic Forwarding	All the data traffic will be sent out via GRE tunnel when this function is enabled.
Remote Subnet	Enter the remote subnet IP address of GRE tunnel.
Remote Netmask	Enter the remote netmask of GRE tunnel.
MTU	Enter the maximum transmission unit. Range: 64-1500.
Key	Set GRE tunnel key.
Enable NAT	Enable NAT traversal function.

Table 3-4-6-4 GRE Parameters

3.4.6.4 L2TP

Layer Two Tunneling Protocol (L2TP) is an extension of the Point-to-Point Tunneling Protocol (PPTP) used by an Internet service provider (ISP) to enable the operation of a virtual private network (VPN) over the Internet.

Figure 3-4-6-6

L2TP	
Item	Description
Enable	Check to enable L2TP function.
Remote IP Address	Enter the public IP address or domain name of L2TP server.

Username	Enter the username that L2TP server provides.
Password	Enter the password that L2TP server provides.
Authentication	Select from "Auto", "PAP", "CHAP", "MS-CHAPv1" and "MS-CHAPv2".
Global Traffic Forwarding	All of the data traffic will be sent out via L2TP tunnel after this function is enabled.
Remote Subnet	Enter the remote IP address that L2TP protects.
Remote Subnet Mask	Enter the remote netmask that L2TP protects.
Key	Enter the password of L2TP tunnel.
Use L2TP Peer DNS	Enable to use the DNS address of peer L2TP server .

Table 3-4-6-5 L2TP Parameters

Advanced Settings	<input checked="" type="checkbox"/>
Local IP Address	<input type="text"/>
Peer IP Address	<input type="text"/>
Enable NAT	<input checked="" type="checkbox"/>
Enable MPPE	<input checked="" type="checkbox"/>
Address/Control Compression	<input type="checkbox"/>
Protocol Field Compression	<input type="checkbox"/>
Asyncmap Value	<input type="text" value="ffffff"/>
MRU	<input type="text" value="1500"/>
MTU	<input type="text" value="1500"/>
Link Detection Interval(s)	<input type="text" value="60"/>
Max Retries	<input type="text" value="0"/>
Expert Options	<input type="text"/>

Figure 3-4-6-7

Advanced Settings	
Item	Description
Local IP Address	Set tunnel IP address of L2TP client. Client will obtain tunnel IP address automatically from the server when it's null.
Peer IP Address	Enter tunnel IP address of L2TP server.
Enable NAT	Enable NAT traversal function.
Enable MPPE	Enable MPPE encryption.
Address/Control Compression	For PPP initialization. User can keep the default option.
Protocol Field Compression	For PPP initialization. User can keep the default option.
Asyncmap Value	One of the PPP protocol initialization strings. User can keep the default value. Range: 0-ffffff.

MRU	Set the maximum receive unit. Range: 64-1500.
MTU	Set the maximum transmission unit. Range: 64-1500
Link Detection Interval (s)	Set the link detection interval time to ensure tunnel connection. Range: 0-600.
Max Retries	Set the maximum times of retry to detect the L2TP connection failure. Range: 0-10.
Expert Options	User can enter some other PPP initialization strings in this field and separate the strings with blank space.

Table 3-4-6-6 L2TP Parameters

3.4.6.5 PPTP

Point-to-Point Tunneling Protocol (PPTP) is a protocol that allows corporations to extend their own corporate network through private "tunnels" over the public Internet. Effectively, a corporation uses a wide-area network as a single large local area network.

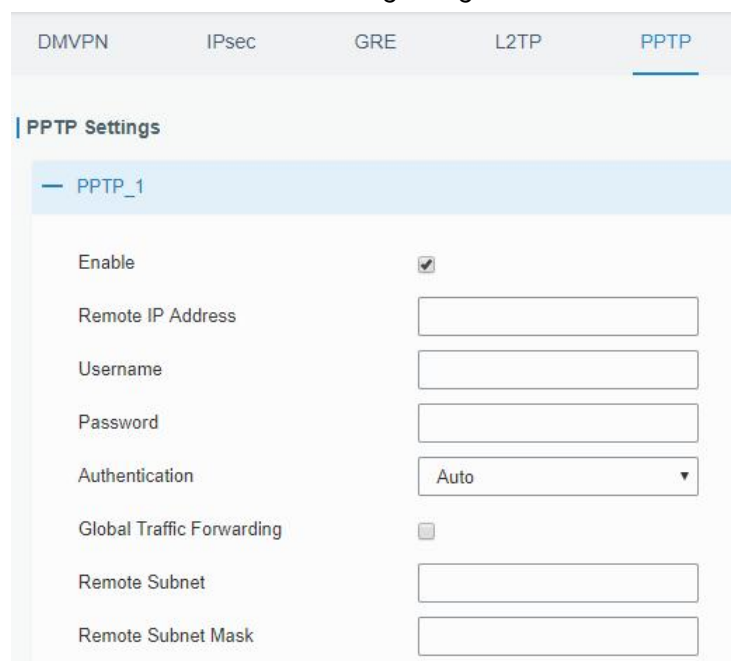

Figure 3-4-6-8

PPTP	
Item	Description
Enable	Enable PPTP client. A maximum of 3 tunnels is allowed.
Remote IP Address	Enter the public IP address or domain name of PPTP server.
Username	Enter the username that PPTP server provides.
Password	Enter the password that PPTP server provides.
Authentication	Select from "Auto", "PAP", "CHAP", "MS-CHAPv1", and "MS-CHAPv2".
Global Traffic Forwarding	All of the data traffic will be sent out via PPTP tunnel once enable this function.
Remote Subnet	Set the peer subnet of PPTP.

Remote Subnet Mask	Set the netmask of peer PPTP server.
--------------------	--------------------------------------

Table 3-4-6-7 PPTP Parameters

Advanced Settings	<input checked="" type="checkbox"/>
Local IP Address	<input type="text"/>
Peer IP Address	<input type="text"/>
Enable NAT	<input checked="" type="checkbox"/>
Enable MPPE	<input checked="" type="checkbox"/>
Address/Control Compression	<input type="checkbox"/>
Protocol Field Compression	<input type="checkbox"/>
Asyncmap Value	<input type="text" value="ffffff"/>
MRU	<input type="text" value="1500"/>
MTU	<input type="text" value="1500"/>
Link Detection Interval(s)	<input type="text" value="60"/>
Max Retries	<input type="text" value="0"/>
Expert Options	<input type="text"/>

Figure 3-4-6-9

PPTP Advanced Settings	
Item	Description
Local IP Address	Set IP address of PPTP client.
Peer IP Address	Enter tunnel IP address of PPTP server.
Enable NAT	Enable the NAT function of PPTP.
Enable MPPE	Enable MPPE encryption.
Address/Control Compression	For PPP initialization. User can keep the default option.
Protocol Field Compression	For PPP initialization. User can keep the default option.
Asyncmap Value	One of the PPP protocol initialization strings. User can keep the default value. Range: 0-ffffff.
MRU	Enter the maximum receive unit. Range: 0-1500.
MTU	Enter the maximum transmission unit. Range: 0-1500.
Link Detection Interval (s)	Set the link detection interval time to ensure tunnel connection. Range: 0-600.
Max Retries	Set the maximum times of retrying to detect the PPTP connection failure. Range: 0-10.
Expert Options	User can enter some other PPP initialization strings in this field and separate the strings with blank space.

Table 3-4-6-8 PPTP Parameters

3.4.6.6 OpenVPN Client

OpenVPN is an open source virtual private network (VPN) product that offers a simplified security framework, modular network design, and cross-platform portability. UG67 supports running at most 3 OpenVPN clients at the same time.

Figure 3-4-6-10

OpenVPN Client	
Item	Description
Enable	Enable OpenVPN client. A maximum of 3 tunnels is allowed.
Protocol	Select from "UDP" and "TCP".
Remote IP Address	Enter remote OpenVPN server's IP address or domain name.
Port	Enter the listening port number of remote OpenVPN server. Range: 1-65535.
Interface	Select from "tun" and "tap".
Authentication	Select authentication type used to secure data sessions. Pre-shared: use the same secret key as server to complete the authentication. After selecting, go to Network > VPN > Certifications page to import a static.key to PSK field.

	<p>Username/Password: use username/password which is preset in server side to complete the authentication.</p> <p>X.509 cert: use X.509 type certificate to complete the authentication. After selecting, go to Network > VPN > Certifications page to import CA certificate, client certificate and client private key to corresponding fields.</p> <p>X.509 cert + user: use both username/password and X.509 cert authentication type.</p>
Local Tunnel IP	Set local tunnel address.
Remote Tunnel IP	Enter remote tunnel address.
Global Traffic Forwarding	All the data traffic will be sent out via OpenVPN tunnel when this function is enabled.
Enable TLS Authentication	<p>Disable or enable TLS authentication when authentication type is X.509 cert. After being enabled, go to Network > VPN > Certifications page to import a ta.key to TA field.</p> <p>Note: this option only supports tls-auth. For tls-crypt, please add this format string on expert option: <code>tls-crypt /etc/openvpn/openvpn-client1-ta.key</code></p>
Username	Enter username provided by OpenVPN server.
Password	Enter password provided by OpenVPN server.
Enable NAT	Enable NAT traversal function.
Compression	Select LZO to compress data.
Link Detection Interval (s)	Set link detection interval time to ensure tunnel connection. Range: 10-1800.
Link Detection Timeout (s)	Set link detection timeout. OpenVPN will be reestablished after timeout. Range: 60-3600.
Cipher	Select from "NONE", "BF-CBC", "DE-CBC", "DES-EDE3-CBC", "AES-128-CBC", "AES-192-CBC" and "AES-256-CBC".
MTU	Enter the maximum transmission unit. Range: 128-1500.
Max Frame Size	Set the maximum frame size. Range: 128-1500.
Verbose Level	Select from "ERROR", "WARNING", "NOTICE" and "DEBUG".
Expert Options	User can enter some other initialization strings in this field and separate the strings with semicolon.
Local Route	
Subnet	Set the local route's IP address.
Subnet Mask	Set the local route's netmask.

Table 3-4-6-9 OpenVPN Client Parameters

3.4.6.7 OpenVPN Server

UG67 supports OpenVPN server to create secure point-to-point or site-to-site connections in routed or bridged configurations and remote access facilities.

DMVPN	IPsec	GRE	L2TP	PPTP	OpenVPN Client	OpenVPN Server
OpenVPN Server Settings						
Enable	<input type="checkbox"/>					
Protocol	UDP					
Port	1194					
Listening IP						
Interface	tun					
Authentication	None					
Local Virtual IP						
Remote Virtual IP						
Enable NAT	<input checked="" type="checkbox"/>					
Compression	LZO					
Link Detection Interval	60					
Cipher	None					
MTU	1500					
Max Frame Size	1500					
Verbose Level	ERROR					
Expert Options						

Figure 3-4-6-11

Local Route		
Subnet	Netmask	Operation
		<input style="background-color: #007bff; color: white; border: none; padding: 2px 5px; border-radius: 3px;" type="button" value="+"/>

Account		
Username	Password	Operation
		<input style="background-color: #007bff; color: white; border: none; padding: 2px 5px; border-radius: 3px;" type="button" value="+"/>

Figure 3-4-6-12

OpenVPN Server	
Item	Description
Enable	Enable/disable OpenVPN server.
Protocol	Select from TCP and UDP.
Port	Fill in listening port number. Range: 1-65535.
Listening IP	Enter WAN IP address or LAN IP address. Leaving it blank refers to all active WAN IP and LAN IP address.
Interface	Select from " tun" and "tap".
Authentication	Select authentication type used to secure data sessions. Pre-shared: use the same secret key as server to complete the authentication. After selecting, go to Network > VPN > Certifications page to import a static.key to PSK field.

	<p>Username/Password: use username/password which is preset in server side to complete the authentication.</p> <p>X.509 cert: use X.509 type certificate to complete the authentication. After selecting, go to Network > VPN > Certifications page to import CA certificate, client certificate and client private key to corresponding fields.</p> <p>X.509 cert + user: use both username/password and X.509 cert authentication type.</p>
Local Virtual IP	The local tunnel address of OpenVPN's tunnel.
Remote Virtual IP	The remote tunnel address of OpenVPN's tunnel.
Client Subnet	Local subnet IP address of OpenVPN client.
Client Netmask	Local netmask of OpenVPN client.
Renegotiation Interval(s)	Renegotiate data channel key after this interval. 0 means disable. Range: 0-86400.
Max Clients	Maximum OpenVPN client number. Range: 1-128.
Enable TLS Authentication	<p>Disable or enable TLS authentication when authentication type is X.509 cert. After being enabled, go to Network > VPN > Certifications page to import a ta.key to TA field.</p> <p>Note: this option only supports tls-auth. For tls-crypt, please add this format string on expert option: <code>tls-crypt /etc/openvpn/openvpn-client1-ta.key</code></p>
Enable CRL	Enable or disable CRL verify.
Enable Client to Client	Allow access between different OpenVPN clients.
Enable Dup Client	Allow multiple users to use the same certification.
Enable NAT	Check to enable the NAT traversal function.
Compression	Select "LZO" to compress data.
Link Detection Interval	Set link detection interval time to ensure tunnel connection. Range: 10-1800.
Cipher	Select from "NONE", "BF-CBC", "DES-CBC", "DES-EDE3-CBC", "AES-128-CBC", "AES-192-CBC" and "AES-256-CBC".
MTU	Enter the maximum transmission unit. Range: 64-1500.
Max Frame Size	Set the maximum frame size. Range: 64-1500.
Verbose Level	Select from "ERROR", "WARNING", "NOTICE" and "DEBUG".
Expert Options	User can enter some other initialization strings in this field and separate the strings with semicolon..
Local Route	
Subnet	The real local IP address of OpenVPN client.
Netmask	The real local netmask of OpenVPN client.
Account	
Username & Password	Set username and password for OpenVPN client.
Client Subnet	
Name	Set the name as OpenVPN client certificate common name.
Subnet	Set the subnet of OpenVPN client.

Subnet Mask	Set the subnet netmask of OpenVPN client.
-------------	---

Table 3-4-6-10 OpenVPN Server Parameters

3.4.6.8 Certifications

When working as OpenVPN server, OpenVPN client or IPsec Server, user can import/export necessary certificate and key files to this page according to the authentication types.

The screenshot shows the 'OpenVPN Client' configuration interface. It features a header 'OpenVPN Client' and a sub-header 'OpenVPN client_1'. Below this, there are six rows of configuration fields: CA, Public Key, Private Key, TA, Preshared Key, and PKCS12. Each row contains a text input field, a blue 'Browse' button, and three grey buttons labeled 'Import', 'Export', and 'Delete'. At the bottom, there are two expandable sections for 'OpenVPN client_2' and 'OpenVPN client_3', each indicated by a plus sign.

Figure 3-4-6-13

The screenshot shows the 'OpenVPN Server' configuration interface. It features a header 'OpenVPN Server' and a sub-header 'OpenVPN Server'. Below this, there are seven rows of configuration fields: CA, Public Key, Private Key, DH, TA, CRL, and Preshared Key. Each row contains a text input field, a blue 'Browse' button, and three grey buttons labeled 'Import', 'Export', and 'Delete'.

Figure 3-4-6-14

The screenshot shows the 'IPsec' configuration interface. It features a header 'IPsec' and a sub-header 'IPsec_1'. Below this, there are five rows of configuration fields: CA, Client Key, Server Key, Private Key, and CRL. Each row contains a text input field, a blue 'Browse' button, and three grey buttons labeled 'Import', 'Export', and 'Delete'.

Figure 3-4-6-15

3.5 System

This section describes how to configure general settings, such as administration account, access service, system time, common user management, SNMP, event alarms, etc.

3.5.1 General Settings

3.5.1.1 General

General settings include system info, access service and HTTPS certificates.

Figure 3-5-1-1

General		
Item	Description	Default
System		
Hostname	User-defined gateway name, needs to start with a letter.	GATEWAY
Web Login Timeout (s)	You need to log in again if it times out. Range: 100-3600.	1800
Access Service		
Port	Set port number of the services. Range: 1-65535.	--
HTTP	Users can log in the device locally via HTTP to access and control it through Web after the option is checked.	80
HTTPS	Users can log in the device locally and remotely via HTTPS to access and control it through Web after option is checked.	443
TELNET	Users can log in the device locally and remotely via	23

	TELNET to access and control it through Web after option is checked.	
SSH	Users can log in the device locally and remotely via SSH after the option is checked.	22
HTTPS Certificates		
Certificate	Click "Browse" button, choose certificate file on the PC, and then click "Import" button to upload the file into gateway. Click "Export" button will export the file to the PC. Click "Delete" button will delete the file.	--
Key	Click "Browse" button, choose key file on the PC, and then click "Import" button to upload the file into gateway. Click "Export" button will export file to the PC. Click "Delete" button will delete the file.	--

Table 3-5-1-1 General Setting Parameters

3.5.1.2 System Time

This section explains how to set the system time including time zone and time synchronization type.

Note: to ensure that the gateway runs with the correct time, it's recommended that you set the system time when configuring the gateway.

Figure 3-5-1-2

System Time	
Item	Description
Current Time	Show the current system time.
Time Zone	Click the drop down list to select the time zone you are in.
Sync Type	Click the drop down list to select the time synchronization type. Sync with Browser: Synchronize time with browser. Sync with NTP Server: Synchronize time with NTP Server. Set up Manually: configure the time manually.
Sync with NTP Server	
NTP Server Address	Set NTP server address (domain name/IP).

Enable NTP Server	After checked, NTP client on the network can achieve time synchronization with gateway.
-------------------	---

Table 3-5-1-2 System Time Parameters

3.5.1.3 SMTP

SMTP, short for Simple Mail Transfer Protocol, is a TCP/IP protocol used in sending and receiving e-mail. This section describes how to configure email settings.

Figure 3-5-1-3

SMTP	
Item	Description
SMTP Client Settings	
Enable	Enable or disable SMTP client function.
Email Address	Enter the sender's email account.
Password	Enter the sender's email password.
SMTP Server Address	Enter SMTP server's domain name.
Port	Enter SMTP server port. Range: 1-65535.
Enable TLS	Enable or disable TLS encryption.

Table 3-5-1-3 SMTP Setting

Related Topics

[Events Setting](#)

3.5.1.4 Phone

Phone settings involve in call/SMS trigger and SMS alarm for events. This is only applied to

gateway with cellular feature.

Name	Number	Operation
List1	654321;123456	<input type="button" value="x"/> <input type="button" value="+"/>

Save

Figure 3-5-1-4

Phone	
Item	Description
Phone Number List	
Name	Set phone group name.
Number	Enter the telephone number. Digits, "+" and "-" are allowed. You can divide multiple numbers by “;”.

Table 3-5-1-4 Phone Settings

Related Topic

[Connect on Demand](#)

3.5.1.5 Email

Email settings involve email alarm for events.

Name	Email Address	Operation
list1	sam@user.com;hot@gmail.com	<input type="button" value="x"/> <input type="button" value="+"/>

Save

Figure 3-5-1-5

Email	
Item	Description
Email List	
Name	Set Email group name.
Email Address	Enter the Email address. You can divide multiple Email addresses by “;”.

Table 3-5-1-5 Email Settings

3.5.2 User Management

3.5.2.1 Account

Here you can change the login username and password of the administrator.

Note: it is strongly recommended that you modify them for the sake of security.

The screenshot shows a web interface with two tabs: 'Account' and 'User Management'. The 'Account' tab is active. Below the tabs is a section titled 'Change Account Info'. It contains four input fields: 'Username' (with the value 'admin'), 'Old Password', 'New Password', and 'Confirm New Password'. A blue 'Save' button is located at the bottom left of the form.

Figure 3-5-2-1

Account	
Item	Description
Username	Enter a new username. You can use characters such as a-z, 0-9, "_", "-". The first character can't be a digit.
Old Password	Enter the old password.
New Password	Enter a new password.
Confirm New Password	Enter the new password again.

Table 3-5-2-1 Account Information

3.5.2.2 User Management

This section describes how to create common user accounts.

The common user permission includes Read-Only and Read-Write.

The screenshot shows a web interface with two tabs: 'Account' and 'User Management'. The 'User Management' tab is active. Below the tabs is a section titled 'User List'. It contains a table with four columns: 'Username', 'Password', 'Permission', and 'Operation'. There are two rows of user data. The first row has 'steve' in the Username column, '*****' in the Password column, 'Read-Write' in the Permission column, and a delete icon (X) in the Operation column. The second row has 'test' in the Username column, '*****' in the Password column, 'Read-Only' in the Permission column, and a delete icon (X) in the Operation column. A plus icon (+) is located at the bottom right of the table.

Figure 3-5-2-2

User Management	
Item	Description
Username	Enter a new username. You can use characters such as a-z, 0-9, "_", "-". The first character can't be a digit.
Password	Set password.

Permission	<p>Select user permission from “Read-Only” and “Read-Write”.</p> <ul style="list-style-type: none"> - Read-Only: users can only view the configuration of gateway in this level. - Read-Write: users can view and set the configuration of gateway in this level.
------------	---

Table 3-5-2-2 User Management

3.5.3 SNMP

SNMP is widely used in network management for network monitoring. SNMP exposes management data with variables form in managed system. The system is organized in a management information base (MIB) which describes the system status and configuration. These variables can be remotely queried by managing applications.

Configuring SNMP in networking, NMS, and a management program of SNMP should be set up at the Manager.

Configuration steps are listed as below for achieving query from NMS:

1. Enable SNMP setting.
2. Download MIB file and load it into NMS.
3. Configure MIB View.
4. Configure VCAM.

3.5.3.1 SNMP

UG67 supports SNMPv1, SNMPv2c and SNMPv3 version. SNMPv1 and SNMPv2c employ community name authentication. SNMPv3 employs authentication encryption by username and password.

Figure 3-5-3-1

SNMP Settings	
Item	Description
Enable	Enable or disable SNMP function.
Port	Set SNMP listened port. Range: 1-65535. The default port is 161.
System Name	Fill in the system name to represent the gateway.
SNMP Version	Select SNMP version; support SNMP v1/v2c/v3.
Location Information	Fill in the location information.
Contact Information	Fill in the contact information.

Table 3-5-3-1 SNMP Parameters

3.5.3.2 MIB View

This section explains how to configure MIB view for the objects.

View Name	View Filter	View OID	Operation
All	Included	1	X
system	Included	1.3.6.1.2.1.1	X

Figure 3-5-3-2

MIB View	
Item	Description
View Name	Set MIB view's name.
View Filter	Select from "Included" and "Excluded".
View OID	Enter the OID number.
Included	You can query all nodes within the specified MIB node.
Excluded	You can query all nodes except for the specified MIB node.

Table 3-5-3-2 MIB View Parameters

3.5.3.3 VACM

This section describes how to configure VCAM parameters.

Community	Permission	MIB View	Network	Operation
private	Read-write	All	0.0.0.0/0	X
public	Read-only	none	0.0.0.0/0	X

Figure 3-5-3-3

VACM	
Item	Description
SNMP v1 & v2 User List	
Community	Set the community name.
Permission	Select from "Read-Only" and "Read-Write".
MIB View	Select an MIB view to set permissions from the MIB view list.
Network	The IP address and bits of the external network accessing the MIB view.
Read-Write	The permission of the specified MIB node is read and write.
Read-Only	The permission of the specified MIB node is read only.
SNMP v3 User List	
Group Name	Set the name of SNMPv3 group.
Security Level	Select from "NoAuth/NoPriv", "Auth/NoPriv", and "Auth/Priv".
Read-Only View	Select an MIB view to set permission as "Read-only" from the MIB view list.
Read-Write View	Select an MIB view to set permission as "Read-write" from the MIB view list.
Inform View	Select an MIB view to set permission as "Inform" from the MIB view list.

Table 3-5-3-3 VACM Parameters

3.5.3.4 Trap

This section explains how to enable network monitoring by SNMP trap.

SNMP	MIB View	VACM	Trap	MIB
SNMP Trap				
Enable	<input checked="" type="checkbox"/>			
SNMP Version	SNMPv2			
Server Address				
Port				
Name				

Figure 3-5-3-4

SNMP Trap	
Item	Description
Enable	Enable or disable SNMP Trap function.
SNMP Version	Select SNMP version; support SNMP v1/v2c/v3.
Server Address	Fill in NMS's IP address or domain name.
Port	Fill in UDP port. Port range is 1-65535. The default port is 162.
Name	Fill in the group name when using SNMP v1/v2c; fill in the username when using SNMP v3.
Auth/Priv Mode	Select from "NoAuth & No Priv", "Auth & NoPriv", and "Auth & Priv".

Table 3-5-3-4 Trap Parameters

3.5.3.5 MIB

This section describes how to download MIB files.

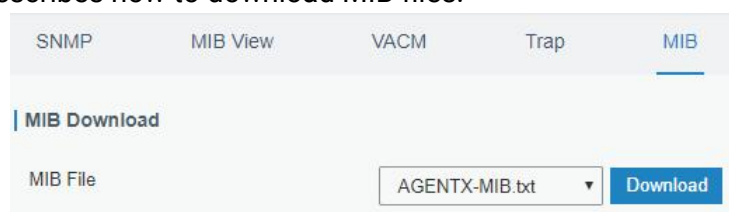

Figure 3-5-3-5

MIB	
Item	Description
MIB File	Select the MIB file you need.
Download	Click "Download" button to download the MIB file to PC.

Table 3-5-3-5 MIB Download

3.5.4 Device Management

3.5.4.1 Auto Provision

Users can customize and select the configuration profile from Milesight Development Platform. When Auto Provision is enabled and the device is connected to Internet, the device will receive the profile to achieve initial configuration. This feature will work even the device does not configure to connect Milesight Development Platform.

The screenshot shows the 'Auto Provision' tab selected. The 'Enable' checkbox is checked. The 'Status' is 'Connection Failed'. A 'Save & Apply' button is visible at the bottom.

3.5.4.2 Management Platform

You can connect the device to the DeviceHub on this page so as to manage the gateway centrally and remotely. For details refer to DeviceHub User Guide.

The screenshot shows the 'Management Platform' tab selected. The 'Enable' checkbox is checked. The 'Platform Type' is set to 'DeviceHub 1.0'. The 'Activation Method' is set to 'By ID'. The 'Status' is 'Disconnected'. A 'Save & Apply' button is visible at the bottom.

Figure 3-5-5-1

Management Platform	
Item	Description
Enable	Enable or disable to connect gateway to management platform.
Platform Type	Milesight DeviceHub 1.0 or Milesight Development Platform is optional.
Status	Show the connection status between the gateway and the management platform.

DeviceHub 1.0	
Activation Server Address	IP address or domain of the DeviceHub.
DeviceHub Management Address	The URL address for the device to connect to the DeviceHub, e.g. http://220.82.63.79:8080/acs.
Activation Method	Select activation method to connect the gateway to the DeviceHub server, options are "By Authentication ID" and "By ID".
Authentication Code	Fill in the authentication code generated from the DeviceHub.
ID	Fill in the registered DeviceHub account (email) and password.
Password	

Table 3-5-5-1

3.5.5 Events

Event feature is capable of sending alerts by Email when certain system events occur.

3.5.5.1 Events

You can view alarm messages on this page.

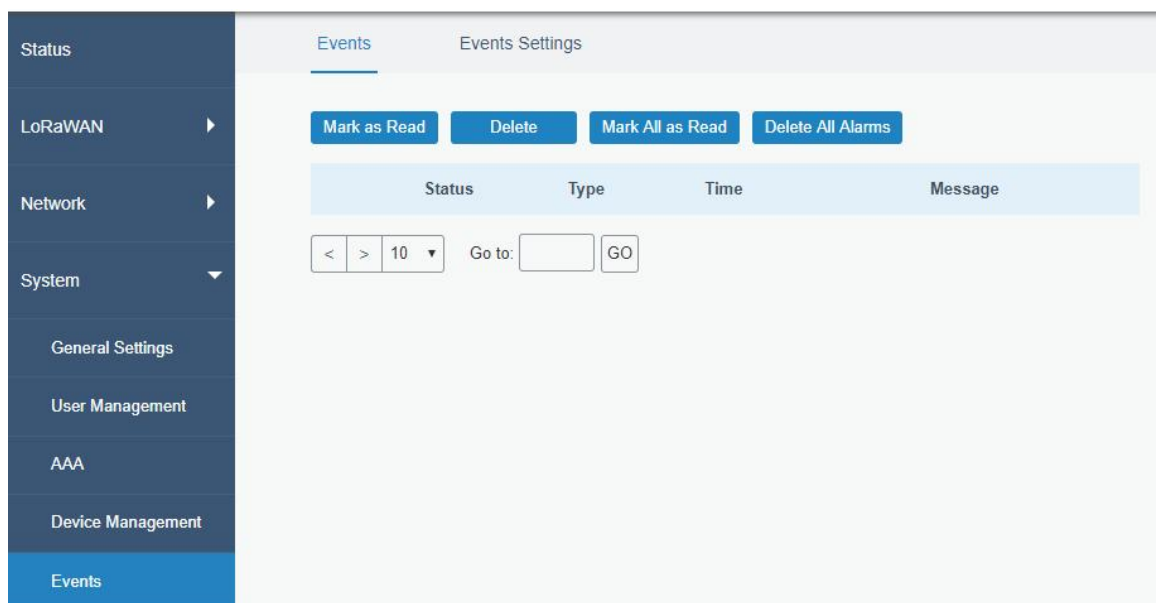

Figure 3-5-6-1

Events	
Item	Description
Mark as Read	Mark the selected event alarm as read.
Delete	Delete the selected event alarm.
Mark All as Read	Mark all event alarms as read.
Delete All Alarms	Delete all event alarms.
Status	Show the reading status of the event alarms.
Type	Show the event type that should be alarmed.

Time	Show the alarm time.
Message	Show the alarm content.

Table 3-5-6-1 Events Parameters

3.5.5.2 Events Settings

In this section, you can decide what events to record and whether you want to receive email and SMS notifications when any change occurs.

Events Settings

Enable

Phone for Notification

Email for Notification

Events	Record	Email Email Setting	SMS SMS Setting
Cellular Up	<input type="checkbox"/>	<input type="checkbox"/>	<input type="checkbox"/>
Cellular Down	<input type="checkbox"/>	<input type="checkbox"/>	<input type="checkbox"/>
WAN Up	<input type="checkbox"/>	<input type="checkbox"/>	<input type="checkbox"/>
WAN Down	<input type="checkbox"/>	<input type="checkbox"/>	<input type="checkbox"/>
VPN Up	<input type="checkbox"/>	<input type="checkbox"/>	<input type="checkbox"/>
VPN Down	<input type="checkbox"/>	<input type="checkbox"/>	<input type="checkbox"/>
Power On	<input type="checkbox"/>	<input type="checkbox"/>	<input type="checkbox"/>
Power Off	<input type="checkbox"/>	<input type="checkbox"/>	<input type="checkbox"/>
Connect to UPS External Power Supplies	<input checked="" type="checkbox"/>	<input type="checkbox"/>	<input type="checkbox"/>
Connect to UPS Internal Battery	<input checked="" type="checkbox"/>	<input type="checkbox"/>	<input type="checkbox"/>
UPS Low Power (20%)	<input checked="" type="checkbox"/>	<input type="checkbox"/>	<input type="checkbox"/>
UPS Abnormal Charging	<input checked="" type="checkbox"/>	<input type="checkbox"/>	<input type="checkbox"/>
Disconnect the UPS	<input checked="" type="checkbox"/>	<input type="checkbox"/>	<input type="checkbox"/>

Figure 3-5-6-2

Event Settings	
Item	Description
Enable	Check to enable "Events Settings".
Phone for Notification	Select phone group to receive SMS alarm.
Email for Notification	Select Email group to receive Email alarm.
Events	Event type the gateway supports to record.

Record	The relevant content of event alarm will be recorded on "Event" page if this option is checked.
Email	The relevant content of event alarm will be sent out via email if this option is checked.
Email Setting	Click and you will be redirected to the page "Email" to configure the Email group.
SMS	The relevant content of event alarm will be sent out via SMS if this option is checked.
SMS Setting	Click and you will be redirected to the page of "Phone" to configure phone group list.

Table 3-5-6-2 Events Parameters

Related Topics

[Email Setting](#)

[Phone Setting](#)

3.6 Maintenance

This section describes system maintenance tools and management.

3.6.1 Tools

Troubleshooting tools includes ping and traceroute.

3.6.1.1 Ping

Ping tool is engineered to ping outer network.

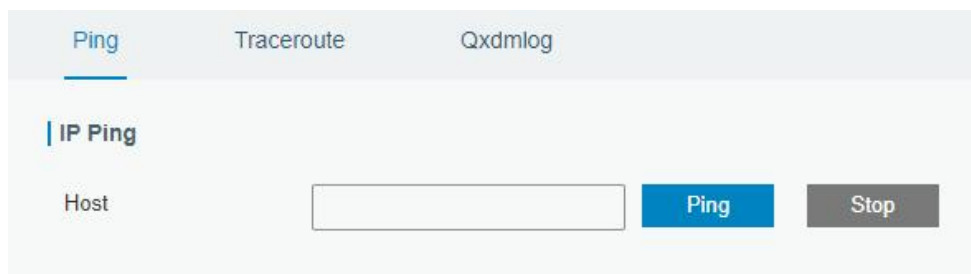

Figure 3-6-1-1

PING	
Item	Description
Host	Ping outer network from the gateway.

Table 3-6-1-1 IP Ping Parameters

3.6.1.2 Traceroute

Traceroute tool is used for troubleshooting network routing failures.

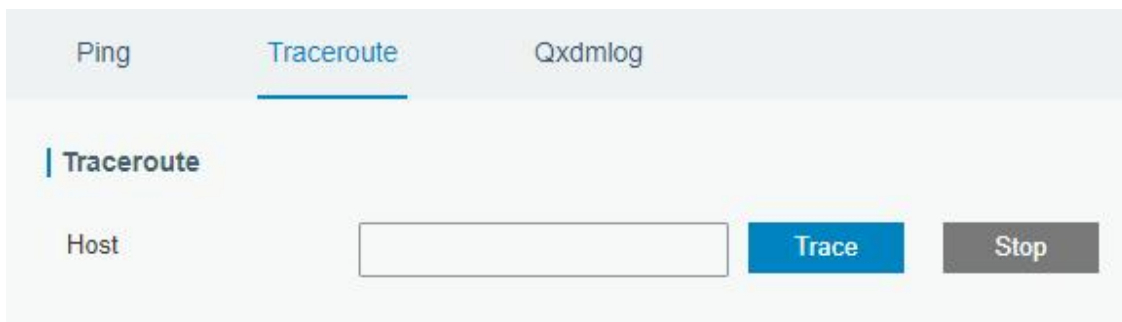

Figure 3-6-1-2

Traceroute	
Item	Description
Host	Address of the destination host to be detected.

Table 3-6-1-2 Traceroute Parameters

3.6.1.3 Qxdmlog

This section allow collecting diagnostic logs of cellular module via QXDM tool.



Figure 3-6-1-3

3.6.2 Schedule

This section explains how to configure scheduled reboot on the gateway.

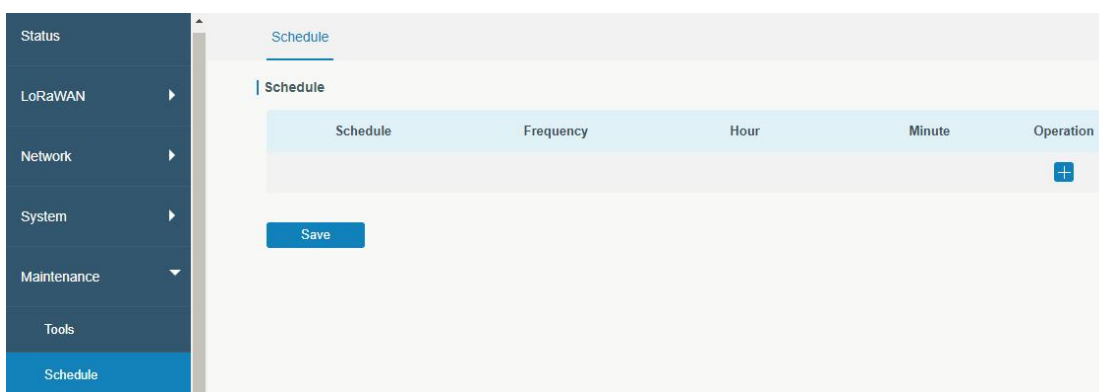

Figure 3-6-2-1

Schedule	
Item	Description
Schedule	Select schedule event:

	Reboot: Reboot the gateway regularly.
Frequency	Select the frequency to execute the schedule.
Hour & Minute	Select the time to execute the schedule.

Table 3-6-2-1 Schedule Parameters

3.6.3 Log

The system log contains a record of informational, error and warning events that indicates how the system processes. By reviewing the data contained in the log, an administrator or user troubleshooting the system can identify the cause of a problem or whether the system processes are loading successfully. Remote log server is feasible, and gateway will upload all system logs to remote log server such as Syslog Watcher.

3.6.3.1 System Log

This section describes how to download log file and view the recent log on web.

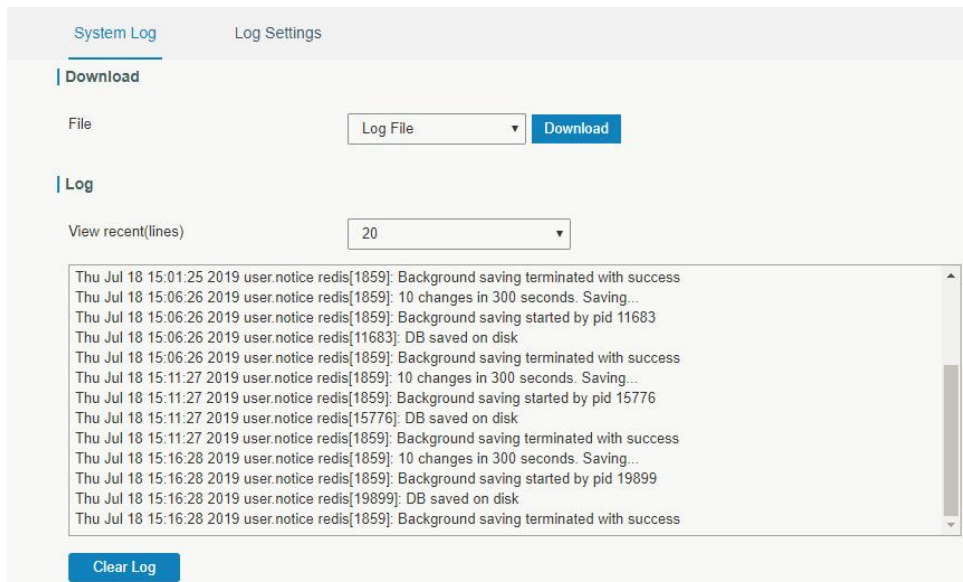

Figure 3-6-3-1

System Log	
Item	Description
Download	Download log file.
View recent (lines)	View the specified lines of system log.
Clear Log	Clear the current system log.

Table 3-6-3-1 System Log Parameters

3.6.3.2 Log Settings

This section explains how to enable remote log server and local log setting.

Figure 3-6-3-2

Log Settings	
Item	Description
Remote Log Server	
Enable	With “Remote Log Server” enabled, gateway will send all system logs to the remote server.
Syslog Server Address	Fill in the remote system log server address (IP/domain name).
Port	Fill in the remote system log server port.
Local Log File	
Storage	User can store the log file in memory.
Size	Set the size of the log file to be stored.
Log Severity	The list of severities follows the syslog protocol.

Table 3-6-3-2 System Log Parameters

3.6.4 Upgrade

This section describes how to upgrade the gateway firmware via web. Generally you don't need to do the firmware upgrade.

Note: any operation on web page is not allowed during firmware upgrade, otherwise the upgrade will be interrupted, or even the device will break down.

The screenshot shows a web interface for upgrading a gateway. At the top, the 'Upgrade' section is highlighted. Underneath, the 'Gateway' section contains the following information:

- Firmware Version:** 60.0.0.42-r5
- Reset Configuration to Factory Default:**
- Upgrade Firmware:** [Text Input Field] [Browse] [Upgrade]

Figure 3-6-4-1

Upgrade	
Item	Description
Firmware Version	Show the current firmware version.
Reset Configuration to Factory Default	When this option is checked, the gateway will be reset to factory defaults after upgrade.
Upgrade Firmware	Click "Browse" button to select the new firmware file, and click "Upgrade" to upgrade firmware.

Table 3-6-4-1 Upgrade Parameters

Related Configuration Example

[Firmware Upgrade](#)

3.6.5 Backup and Restore

This section explains how to create a complete backup of the whole system configurations to a file, replicate parts of important configuration only for batch backup, restore the config file to the gateway and reset to factory defaults.

The screenshot shows a web interface for backup and restore operations. It is organized into three main sections:

- Restore Config:** Includes a 'Config File' input field, a 'Browse' button, and an 'Import' button.
- Backup Running-config:** Includes two buttons: 'Full Backup' and 'Batch Backup'.
- Restore Factory Defaults:** Includes a prominent red 'Reset' button.

Figure 3-6-5-1

Backup and Restore	
Item	Description
Config File	Click "Browse" button to select configuration file, and then click "Import" button to upload the configuration file to the gateway.
Full Backup	Click "Full Backup" to export the current configuration file to the PC.
Batch Backup	Click "Batch Backup" to export current configuration except gateway ID of packet forwarder, all embedded NS settings, static IP address of WAN, WLAN settings, user management settings, DeviceHub authentication code, all APP settings.
Reset	Click "Reset" button to reset factory default settings. gateway will restart after reset process is done.

Table 3-6-5-1 Backup and Restore Parameters

Related Configuration Example

[Restore Factory Defaults](#)

3.6.6 Reboot

On this page you can reboot the gateway and return to the login page. We strongly recommend clicking "Save" button before rebooting the gateway so as to avoid losing the new configuration.

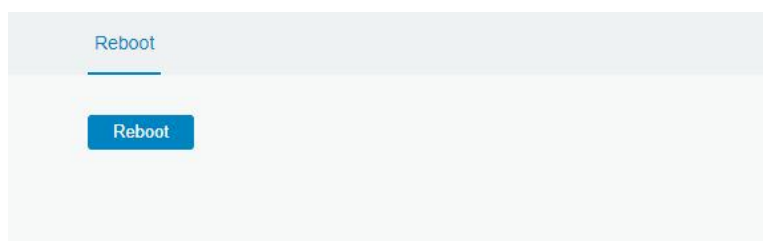

Figure 3-6-6-1

3.7 APP

3.7.1 Python

Python is an object-oriented programming language that has gained popularity because of its clear syntax and readability.

As an interpreted language, Python has a design philosophy that emphasizes code readability, notably using whitespace indentation to delimit code blocks rather than curly brackets or keywords, and a syntax that allows programmers to express concepts in fewer lines of code than it's used in other languages such as C++ or Java. The language provides constructs and intends to enable writing clear programs on both small and large scale.

Users can use Python to quickly generate the prototype of the program, which can be the

final interface of the program, rewrite it with a more appropriate language, and then encapsulate the extended class library that Python can call.

This section describes how to view the relevant running status such as App-manager, SDK version, extended storage, etc. Also you can change the App-manager configuration, and import the Python App package from here.

3.7.1.1 Python

Figure 3-7-1-1

Python	
Item	Description
AppManager Status	Show AppManager's running status, like "Uninstalled", "Running" or "Stopped".
SDK Version	Show the version of the installed SDK.
SDK Path	Show the SDK installation path.
Available Storage	Select available storage to install SDK.
SDK Upload	Upload and install SDK for Python.
Uninstall	Uninstall SDK.
View	View application status managed by AppManager.

Table 3-7-1-1 Python Parameters

3.7.1.2 App Manager Configuration

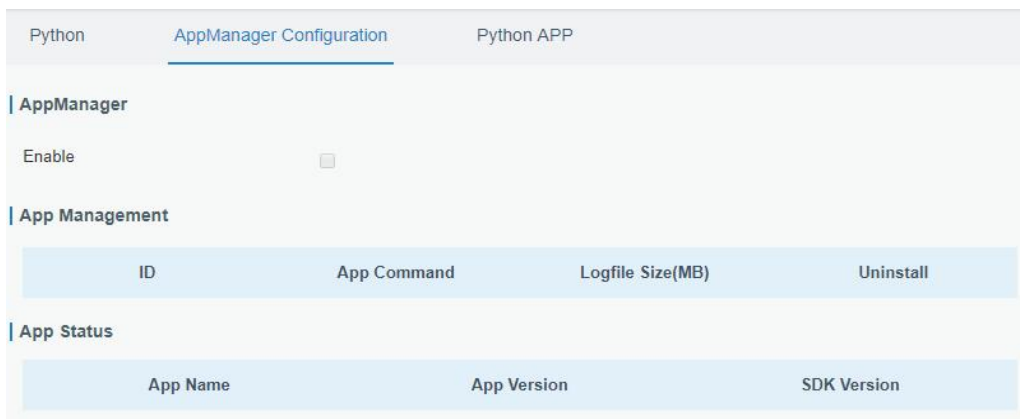

Figure 3-7-1-2

AppManager Configuration	
Item	Description
Enable	After enabling Python AppManager, user can click "View" button on the "Python" webpage to view the application status managed by AppManager.
App Management	
ID	Show the ID of the imported App.
App Command	Show the name of the imported App.
Logfile Size(MB)	User-defined Logfile size. Range: 1-50.
Uninstall	Uninstall APP.
App Status	
App Name	Show the name of the imported App.
App Version	Show the version of the imported App.
SDK Version	Show the SDK version which the imported App is based on.

Table 3-7-1-2 APP Manager Parameters

3.7.1.3 Python App

Figure 3-7-1-3

Python APP	
Item	Description
App Package	Select App package and import.
App Name	Select App to import configuration.
App Configuration	Select configuration file and import.
Debug File	Export script file.
Debug Script	Select Python script to be debugged and import.

Table 3-7-1-3 APP Parameters

3.7.2 Node-RED

Node-RED is a flow-based development tool for visual programming and wiring together hardware devices, APIs and online services as part of the Internet of Things. Node-RED provides a web-browser-based flow editor, which can easily wire together flows using the wide range of nodes in the palette. Besides basic nodes, Milesight gateways provide following customized nodes:

- LoRa Input: receive the LoRa data, please ensure the network server mode is enabled before using this node
- LoRa Output: send downlinks to LoRaWAN® nodes
- Device Filter: filter out the data of one or more specific LoRaWAN® nodes
- GW Info: monitor alarm messages of gateway, please ensure the event detection is enabled in “General -> Events -> Events Settings”
- Email Output: send LoRa data or gateway alarms via email
- SMS Input: receive SMS message. This only works when cellular is connected
- SMS Output: send SMS message. This only works when cellular is connected

3.7.2.1 Node-RED

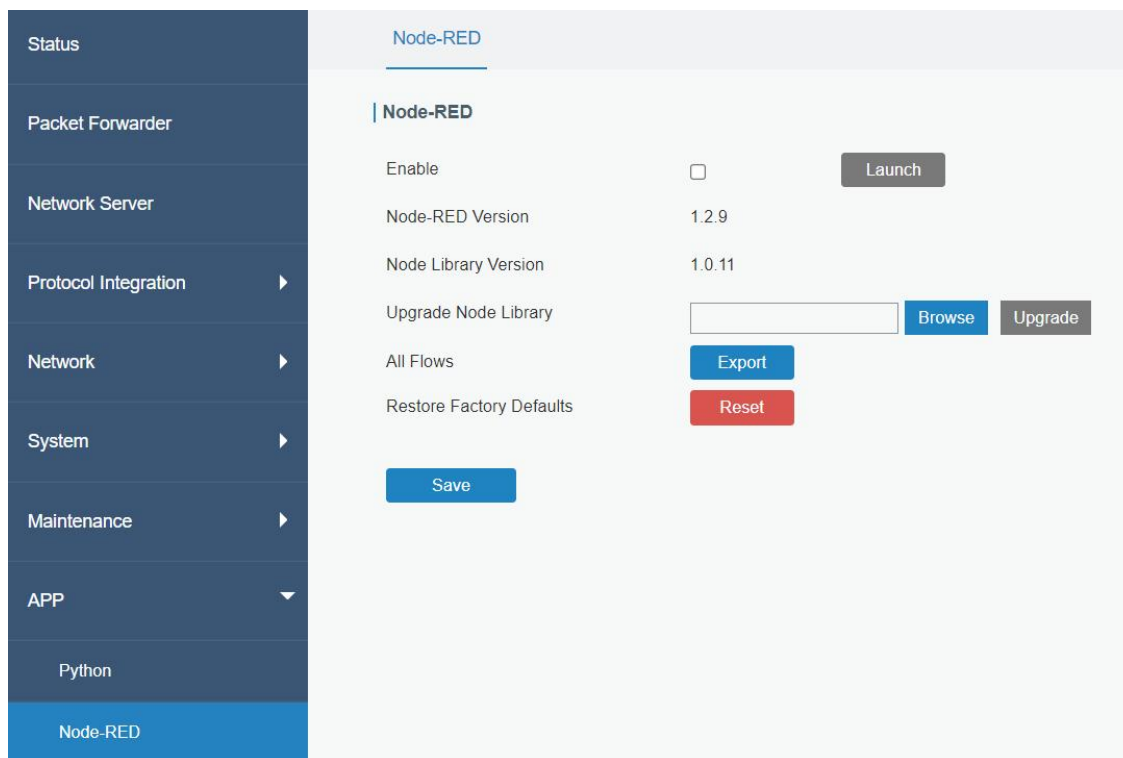

Figure 3-7-2-1

Node-RED	
Item	Description
Enable	Enable the Node-RED.
Launch	Click to launch the web GUI of Node-RED.
Node-RED Version	Show the version of the Node-RED. The Node-RED version can be upgraded only when you upgrade the gateway.
Node Library Version	Show the version of the node library.
Upgrade Node Library	Upgrade the node library by importing the library package.
All Flows Export	Export all flows as a JSON format file.
Restore Factory Default	Erase all flows data of Node-RED.

Table 3-7-2-1 Node-RED Parameters

Related Configuration Example

[Node-RED](#)

Chapter 4 Application Examples

4.1 Restore Factory Defaults

Method 1:

Log in web interface, and go to **Maintenance > Backup and Restore**, click **Reset** button, you will be asked to confirm if you'd like to reset it to factory defaults. Then click **Reset** button.

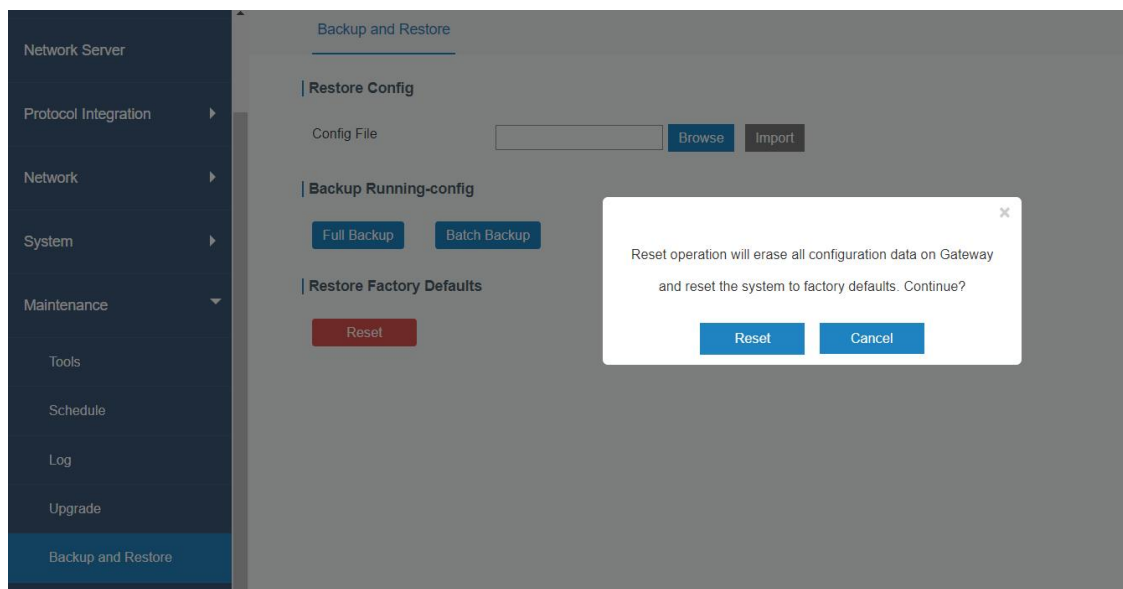

Then the gateway will reboot and restore to factory settings immediately.

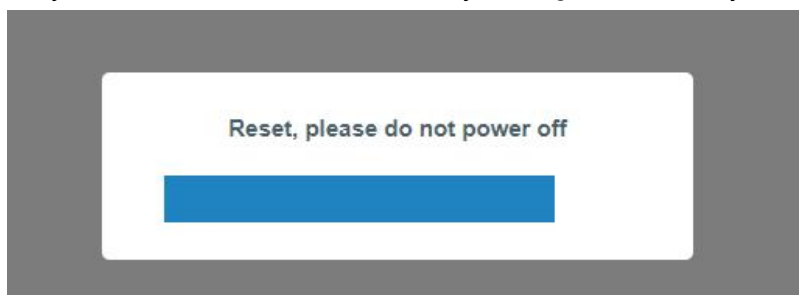

Please wait till SYS light statically and the login page pops up again, which means the gateway has already been reset to factory defaults successfully.

Related Topic

[Restore Factory Defaults](#)

Method 2:

Locate the reset button on the gateway, press and hold the reset button for more than 5s until the SYS LED blinks.

4.2 Firmware Upgrade

It is suggested that you contact Milesight technical support first before you upgrade gateway firmware. Gateway firmware file suffix is “.bin”.

After getting firmware file please refer to the following steps to complete the upgrade.

1. Go to “Maintenance > Upgrade”.
2. Click “Browse” and select the correct firmware file from the PC.
3. Click “Upgrade” and the gateway will check if the firmware file is correct. If it’s correct, the firmware will be imported to the gateway, and then the gateway will start to upgrade.

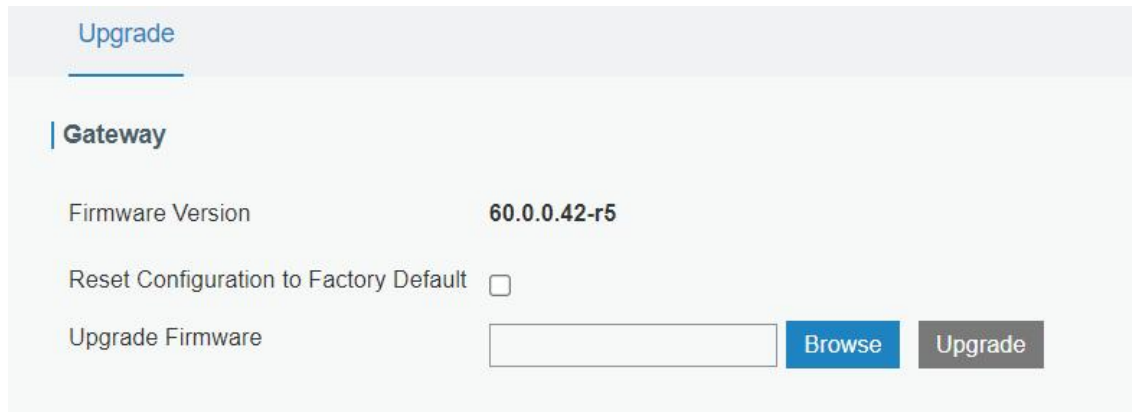

The screenshot shows the 'Upgrade' page in the Milesight gateway management interface. The page title is 'Upgrade'. Under the 'Gateway' section, the 'Firmware Version' is displayed as '60.0.0.42-r5'. There is a checkbox for 'Reset Configuration to Factory Default' which is currently unchecked. Below this, there is a text input field for 'Upgrade Firmware', a blue 'Browse' button, and a grey 'Upgrade' button.

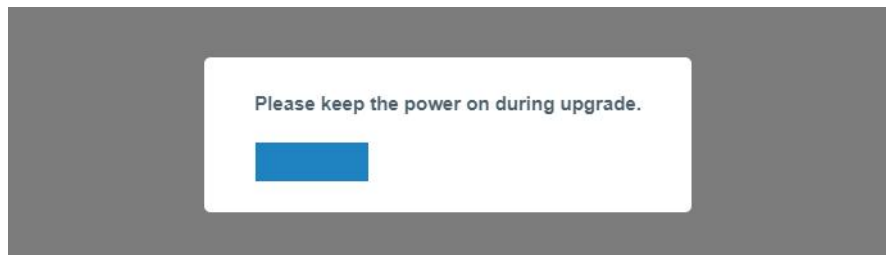

Related Topic

[Upgrade](#)

4.3 Ethernet Connection

1. Go to “Network > Interface > Port” page to select the connection type and configure Ethernet port configuration, click “Save & Apply” for configuration to take effect.

Port	WLAN	Cellular	Loopback	VLAN Trunk
— Port_1				
Port	eth 0			
Connection Type	Static IP			
IP Address	192.168.44.186			
Netmask	255.255.255.0			
Gateway	192.168.44.1			
MTU	1500			
Primary DNS Server	8.8.8.8			
Secondary DNS Server	223.5.5.5			
Enable NAT	<input checked="" type="checkbox"/>			

2. Connect Ethernet port of gateway to devices like router or modem.
3. Go to “Maintenance > Tools > Ping” to check network connectivity.

The screenshot shows the 'Tools' menu on the left with 'Ping' selected. The main area displays the 'IP Ping' tool interface. The host is set to 'www.google.com'. The 'Ping' button is highlighted in blue, and the 'Stop' button is greyed out. The output shows four successful ping requests to 172.217.25.4 with varying response times between 19.750 ms and 20.090 ms. The statistics indicate 4 packets transmitted, 4 received, and 0% packet loss.

Related Topic

[Port Setting](#)

4.4 Cellular Connection (Cellular Version Only)

1. Go to “Network > Interface > Cellular > Cellular Setting” and configure the necessary cellular info of SIM card, lick “Save” and “Apply” for configuration to take effect.

Cellular Setting

Enable	<input checked="" type="checkbox"/>
Network Type	Auto
APN	<input type="text"/>
Username	<input type="text"/>
Password	<input type="text"/>
Access Number	<input type="text"/>
PIN Code	<input type="text"/>
Authentication Type	None
Roaming	<input checked="" type="checkbox"/>
Customize MTU	<input checked="" type="checkbox"/>
MTU	1500
Enable IMS	<input type="checkbox"/>
SMS Center	<input type="text"/>

2. Go to "Status > Cellular" to view the status of the cellular connection. If it shows 'Connected', SIM has dialed up successfully.

Overview	Packet Forward	Cellular	Network	WLAN
Modem				
Status	Ready			
Model	EC25			
Version	EC25ECGAR06A07M1G			
Signal Level	23asu (-67dBm)			
Register Status	Registered (Home network)			
IMEI	860425047368939			
IMSI	460019425301842			
ICCID	89860117838009934120			
ISP	CHN-UNICOM			
Network Type	LTE			
PLMN ID				
LAC	5922			
Cell ID	340db83			
Network				
Status	Connected			
IP Address	10.132.132.59			
Netmask	255.255.255.240			
Gateway	10.132.132.60			

Related Topic

[Cellular Setting](#)

[Cellular Status](#)

4.5 Wi-Fi Application Example

4.5.1 AP Mode

Application Example

Configure UG67 as AP to allow connection from users or devices.

Configuration Steps

1. Go to “Network > Interface > WLAN” to configure wireless parameters as below.

Port	WLAN	Cellular	Loopback
WLAN			
Enable	<input checked="" type="checkbox"/>		
Work Mode	AP		
SSID Broadcast	<input checked="" type="checkbox"/>		
AP Isolation	<input type="checkbox"/>		
Radio Type	802.11n(2.4GHz)		
Channel	Auto		
SSID	Gateway_F1200F		
BSSID	24:e1:24:f1:20:0f		
Encryption Mode	No Encryption		
Bandwidth	20MHz		
Max Client Number	10		

Click “Save” and “Apply” buttons after all configurations are done.

2. Use a smart phone to connect the access point of gateway. Go to “Status > WLAN”, and you can check the AP settings and information of the connected client/user.

Overview	Packet Forward	Cellular	Network	<u>WLAN</u>	VPN
WLAN Status					
Wireless Status	Enabled				
MAC Address	24:e1:24:f1:20:0f				
Interface Type	AP				
SSID	Gateway_F1200F				
Channel	Auto				
Encryption Type	No Encryption				
Status	Up				
IP Address	192.168.1.1				
Netmask	255.255.255.0				
Connection Duration	0 days, 02:40:52				

4.5.2 Client Mode

Application Example

Configure UG67 as Wi-Fi client to connect to an access point to have Internet access.

Configuration Steps

1. Go to "Network > Interface > WLAN" and click "Scan" to search for WiFi access point.

Port	<u>WLAN</u>	Cellular	Loopback				
< GoBack							
SSID	Channel	Signal	Cipher	BSSID	Security	Frequency	
AAA	Auto	-61dBm	AES	24:e1:24:f0:c4:13	WPA-PSK/WPA2-PSK	2412MHz	Join Network

2. Select one access point and click "Join Network", then type the password of the access point.

Port	WLAN	Cellular	Loopback
WLAN			
Enable	<input checked="" type="checkbox"/>		
Work Mode	Client		Scan
SSID	AAA		
BSSID	24:e1:24:f0:c4:13		
Encryption Mode	WPA-PSK/WPA2-PSK		
Cipher	AES		
Key		
IP Setting			
Protocol	DHCP Client		

Click “Save” and “Apply” buttons after all configurations are done.

3. Go to “Status > WLAN”, and you can check the connection status of the client.

Overview	Packet Forward	Cellular	Network	WLAN
WLAN Status				
Wireless Status		Enabled		
MAC Address		24:e1:24:f0:de:14		
Interface Type		Client		
SSID		AAA		
Channel		Auto		
Encryption Type		WPA-PSK/WPA2-PSK		
Cipher		AES		
Status		Connected		
IP Address		192.168.1.145		
Netmask		255.255.255.0		
Connection Duration		0 days, 02:44:45		

Related Topic

[WLAN Setting](#)

[WLAN Status](#)

4.6 Packet Forwarder Configuration

UG67 gateway has installed multiple packet forwarders including Semtech, Basic station, Chirpstack-Generic MQTT broker, etc. Before connecting make sure the gateway has

connected to network.

1. Go to “Packet Forwarder” > “General”.

General Radios Advanced Custom Traffic

General Setting

Gateway EUI 24E124FFFEF12257

Gateway ID

Frequency-Sync

Multi-Destination

ID	Enable	Type	Server Address	Connect Status	Operation
0	Enabled	Embedded NS	localhost	Connected	

2. Click to add a new network server. Fill in the network server information and enable this server.

Enable

Type

Server Address

Port Up

Port Down

Save

3. Go to “Packet Forwarder > Radio” page to configure center frequency and channels. The channels of the gateway and network server need to be the same.

Region

Name	Center Frequency/MHz
Radio 0	<input type="text" value="904.3"/>
Radio 1	<input type="text" value="905.0"/>

Multi Channels Setting

Enable	Index	Radio	Frequency/MHz
<input checked="" type="checkbox"/>	0	<input type="text" value="Radio 0"/>	<input type="text" value="903.9"/>
<input checked="" type="checkbox"/>	1	<input type="text" value="Radio 0"/>	<input type="text" value="904.1"/>
<input checked="" type="checkbox"/>	2	<input type="text" value="Radio 0"/>	<input type="text" value="904.3"/>
<input checked="" type="checkbox"/>	3	<input type="text" value="Radio 0"/>	<input type="text" value="904.5"/>
<input checked="" type="checkbox"/>	4	<input type="text" value="Radio 1"/>	<input type="text" value="904.7"/>
<input checked="" type="checkbox"/>	5	<input type="text" value="Radio 1"/>	<input type="text" value="904.9"/>
<input checked="" type="checkbox"/>	6	<input type="text" value="Radio 1"/>	<input type="text" value="905.1"/>
<input checked="" type="checkbox"/>	7	<input type="text" value="Radio 1"/>	<input type="text" value="905.3"/>

4. Add the gateway on network server page. For more details about the network server connection please refer to [Milesight IoT Support portal](#).
5. Go to "Traffic" page to view the data communication of UG67.

Rfch	Direction	Time	Ticks	Frequency	Datarate	Coderate	RSSI	SNR
0	up	05:57:30	212136749 3	903.9	SF10BW125	4/5	-51	13.2
0	up	05:57:29	211944923 1	904.5	SF7BW125	4/5	-95	8.5
0	up	05:57:13	210431205 7	904.6	SF8BW500	4/5	-51	11.5
0	up	05:57:06	209699855 6	903.9	SF7BW125	4/5	-65	14.2

4.7 Connect to Milesight IoT Cloud

1. Go to "Packet Forwarder > General" page to enable the embedded network server.

Status	General	Radios	Advanced	Custom	Traffic																		
Packet Forwarder	General Setting Gateway EUI: 24E124FFFEF12257 Gateway ID: <input type="text" value="24E124FFFEF12257"/> Frequency-Sync: <input type="text" value="Disabled"/>																						
Network Server	Multi-Destination <table border="1"> <thead> <tr> <th>ID</th> <th>Enable</th> <th>Type</th> <th>Server Address</th> <th>Connect Status</th> <th>Operation</th> </tr> </thead> <tbody> <tr> <td>0</td> <td>Enabled</td> <td>Embedded NS</td> <td>localhost</td> <td>Connected</td> <td> </td> </tr> <tr> <td colspan="6" style="text-align: right;"></td> </tr> </tbody> </table>					ID	Enable	Type	Server Address	Connect Status	Operation	0	Enabled	Embedded NS	localhost	Connected							
ID	Enable	Type	Server Address	Connect Status	Operation																		
0	Enabled	Embedded NS	localhost	Connected																			
Network																							
System																							
Maintenance																							
APP																							

2. Go to "Packet Forwarder > Radio" page to configure center frequency and channels. The channels of the gateway and nodes need to be the same.

Region

Name	Center Frequency/MHz
Radio 0	<input type="text" value="904.3"/>
Radio 1	<input type="text" value="905.0"/>

Multi Channels Setting

Enable	Index	Radio	Frequency/MHz
<input checked="" type="checkbox"/>	0	<input type="text" value="Radio 0"/>	<input type="text" value="903.9"/>
<input checked="" type="checkbox"/>	1	<input type="text" value="Radio 0"/>	<input type="text" value="904.1"/>
<input checked="" type="checkbox"/>	2	<input type="text" value="Radio 0"/>	<input type="text" value="904.3"/>
<input checked="" type="checkbox"/>	3	<input type="text" value="Radio 0"/>	<input type="text" value="904.5"/>
<input checked="" type="checkbox"/>	4	<input type="text" value="Radio 1"/>	<input type="text" value="904.7"/>
<input checked="" type="checkbox"/>	5	<input type="text" value="Radio 1"/>	<input type="text" value="904.9"/>
<input checked="" type="checkbox"/>	6	<input type="text" value="Radio 1"/>	<input type="text" value="905.1"/>
<input checked="" type="checkbox"/>	7	<input type="text" value="Radio 1"/>	<input type="text" value="905.3"/>

3. Go to “Network Server > General” page to enable the network server and “Cloud mode”, then select “Milesight IoT Cloud” mode.

Status	General	Applications	Profiles	Device
Packet Forwarder	General Setting			
Network Server	Enable	<input checked="" type="checkbox"/>		
Network	Cloud Mode	<input checked="" type="checkbox"/>	<input type="text" value="Milesight IoT Cloud"/>	
System	NetID	<input type="text" value="010203"/>		
Maintenance	Join Delay	<input type="text" value="5"/>	sec	
APP	RX1 Delay	<input type="text" value="1"/>	sec	
	Lease Time	<input type="text" value="8760-0-0"/>	hh-mm-ss	
	Log Level	<input type="text" value="info"/>		

4. Log in the Milesight IoT Cloud. Then go to “My Devices” page and click “+New Devices” to add gateway to Milesight IoT Cloud via SN. Gateway will be added under “Gateways” menu.

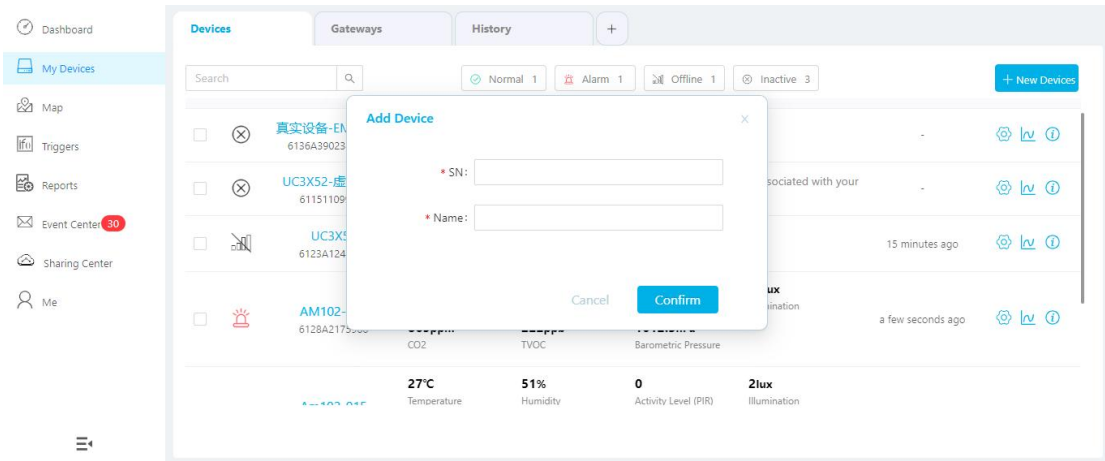

5. The gateway is online on Milesight IoT Cloud.

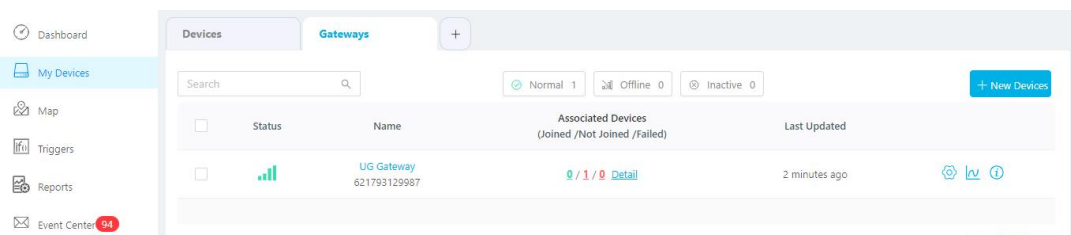

4.8 Application Configuration

You can create a new application on this page, which is mainly used to define the method of decoding the data sent from end-device and choosing the data transport protocol to send data to another server address. The data will be sent to your custom server address using MQTT, HTTP or HTTPS protocol.

1. Go to "Network Server" > "Application".

2. Click  to enter the configuration page, displayed as the following picture:

3. Click "Save" to create this application.

4. Click  to add a data transmission type.

HTTP or HTTPS:

Step 1: select HTTP or HTTPS as transmission protocol.

Step 2: Enter the destination URL. Different types of data can be sent to different URLs.

| URL

Data Type	URL
Uplink data	<input type="text"/>
Join notification	<input type="text"/>
ACK notification	<input type="text"/>
Error notification	<input type="text"/>

Enter the header name and header value if there is user credentials when accessing the HTTP(s) server.

| HTTP Header

Header Name	Header Value	Operation
<input type="text"/>	<input type="text"/>	<input type="button" value="X"/>
		<input type="button" value="+"/>

MQTT:

Step 1: select the transmission protocol as MQTT.

Step 2: Fill in MQTT broker general settings.

| General

Broker Address	<input type="text"/>
Broker Port	<input type="text"/>
Client ID	<input type="text"/>
Connection Timeout/s	<input type="text" value="30"/>
Keep Alive Interval/s	<input type="text" value="60"/>

Step 3: Select the authentication method required by the server.

If you select user credentials for authentication, you need to enter the username and password for authentication.

User Credentials

Enable

Username

Password

If certificate is necessary for verification, please select mode and import CA certificate, client certificate and client key file for authentication.

TLS

Enable

Mode

CA File [Browse](#) [Import](#) [Delete](#)

Client Certificate File [Browse](#) [Import](#) [Delete](#)

Client Key File [Browse](#) [Import](#) [Delete](#)

Step 4: Enter the topic to receive data and choose the QoS.

Data Type	topic	
Uplink data	<input type="text" value="device/test"/>	QoS 0 <input type="text"/>
Downlink data	<input type="text"/>	QoS 0 <input type="text"/>
Multicast downlink data	<input type="text"/>	QoS 0 <input type="text"/>
Join notification	<input type="text"/>	QoS 0 <input type="text"/>
ACK notification	<input type="text"/>	QoS 0 <input type="text"/>
Error notification	<input type="text"/>	QoS 0 <input type="text"/>
Request data	<input type="text" value="/event/request"/>	QoS 0 <input type="text"/>
Response data	<input type="text" value="/event/response"/>	QoS 0 <input type="text"/>

4.9 Device Configuration

Go to "Device" page and click "Add" to add LoRaWAN® node devices. Please select correct device profile according to device type.

Device

[Add](#) [Bulk Import](#) [Delete All](#)

Device Name	Device EUI	Device-Profile	Application	Last Seen	Activated	Operation
No matching records found						

Device Name	<input type="text" value="lora-sensor"/>
Description	<input type="text" value="a short description of your node"/>
Device EUI	<input type="text" value="0000000000000000"/>
Device-Profile	<input type="text" value="ClassA-OTAA"/>
Application	<input type="text" value="cloud"/>
Payload Codec	<input type="text"/>
fPort	<input type="text" value="1"/>
Frame-counter Validation	<input type="checkbox"/>
Application Key	<input type="text"/>
Device Address	<input type="text"/>
Network Session Key	<input type="text"/>
Application Session Key	<input type="text"/>
Uplink Frame-counter	<input type="text" value="0"/>
Downlink Frame-counter	<input type="text" value="0"/>

Save & Apply

You can also click “Bulk Import” if you want to add many nodes all at once.

✕

Import File **Browse** **Import** **Template Download**

Click “Template Download” to download template file and add device information to this file. Application and device profile should be the same as you created on web page.

	A	B	C	D	E	F	G	H	I
1	name	description	deveui	application	deviceprofile	appkey	devaddr	appskey	nwkskey
2	24e1242191323266		24e1242191323266	cloud	ClassC-OTAA	112233445566778899aa112233445566			
3									
4									
5									

Import this file to add bulks of devices.

4.10 Send Data to Device

1. Go to “Network Server” > “Packets”, check the packet in the network server list to make sure that the device has joined the network successful.

1122612191	868100000	SF7BW125	-	-	17	0	JnAcc	2019-08-06T09:22:29+08:00	i
112261219	868100000	SF7BW125	9.5	-77	18	0	JnReq	2019-08-06T09:22:29+08:00	i

2. Fill in the device EUI or select the multicast group which you need to send downlinks.

Then fill in the downlink commands, ports.

Device EUI	Type	Payload	Fport	Confirmed
11226121913	ASCII	15	15	<input checked="" type="checkbox"/>

3. Click "Send".



4. Check the packet in the network server list to make sure that the device has received this message successful. It's suggested to enable "Confirmed". Multicast feature does not support confirmed downlinks.

Device EUI	Type	Payload	Fport	Confirmed
11226121913	ASCII	15	15	<input checked="" type="checkbox"/>

You can click "Refresh" to refresh the list or set automatic refreshing frequency for the list. **If the device's class type is Class C, then the device will constantly receive packets.**

This packet's type is DnCnf (Downlink Confirmed Packet) and if the packet's color is gray, then it means the packet cannot be transmitted now because at least one message has been in the queue. If the packet record is white, it means the packet has been delivered successfully.

1122612191311123	869525000	SF12BW125	-	-	6	2	DnCnf	2019-08-06T09:22:55+08:00	Success	!
1122612191311123	0				6	2	DnCnf		Pending	!

If the device receives this downlink confirmed packet, then the device will reply "ACK" when delivering next.

Device EUI	Frequency	Datarate	SNR	RSSI	Size	Fcnt	Type	Time	Details
11226121913	868300000	SF10BW125	-	-	0	3	DnUnc	2019-08-06T09:23:44+08:00	!
1122612191	868300000	SF10BW125	10.5	-75	64	2	UpCnf	2019-08-06T09:23:44+08:00	!
112261219	869525000	SF12BW125	-	-	6	2	DnCnf	2019-08-06T09:22:55+08:00	!
112261219	0				6	2	DnCnf		!
112261219	868500000	SF10BW125	-	-	0	1	DnUnc	2019-08-06T09:22:49+08:00	!

Packets Details	
Dev Addr	07e7
GwEUI	24e124ff
AppEUI	557240
DevEUI	1122612191311123
Immediately	-
Timestamp	874346044
Type	UpCnf
Adr	false
AdrAckReq	false
Ack	true
Fcnt	21
Fport	55
Modulation	LORA

Ack is "true" means that the device has received this packet.

If the device's class type is Class A, only after the device sends out an uplink packet will the network server sends out data to the device.

Device EUI	Frequency	Datarate	SNR	RSSI	Size	Fcnt	Type	Time	Details
1122612191311123	868300000	SF10BW125	-	-	0	19	DnUnc	2019-08-06T09:49:38+08:00	!
1122612191311123	868300000	SF10BW125	10.8	-76	64	21	ACK	2019-08-06T09:49:38+08:00	!
1122612191311123	868300000	SF10BW125	10.8	-76	64	21	UpCnf	2019-08-06T09:49:38+08:00	!
1122612191311123	868100000	SF10BW125	-	-	6	18	DnCnf	2019-08-06T09:48:43+08:00	Success
1122612191311123	868100000	SF10BW125	9.8	-77	64	20	UpCnf	2019-08-06T09:48:43+08:00	!
1122612191311123	0				6	18	DnCnf	Pending	!
1122612191311123	868500000	SF10BW125	-	-	0	17	DnUnc	2019-08-06T09:47:38+08:00	!
1122612191311123	868500000	SF10BW125	8.0	-76	64	19	UpCnf	2019-08-06T09:47:38+08:00	!
1122612191311123	868100000	SF10BW125	-	-	0	16	DnUnc	2019-08-06T09:46:38+08:00	!
1122612191311123	868100000	SF10BW125	11.2	-74	64	18	UpCnf	2019-08-06T09:46:37+08:00	!

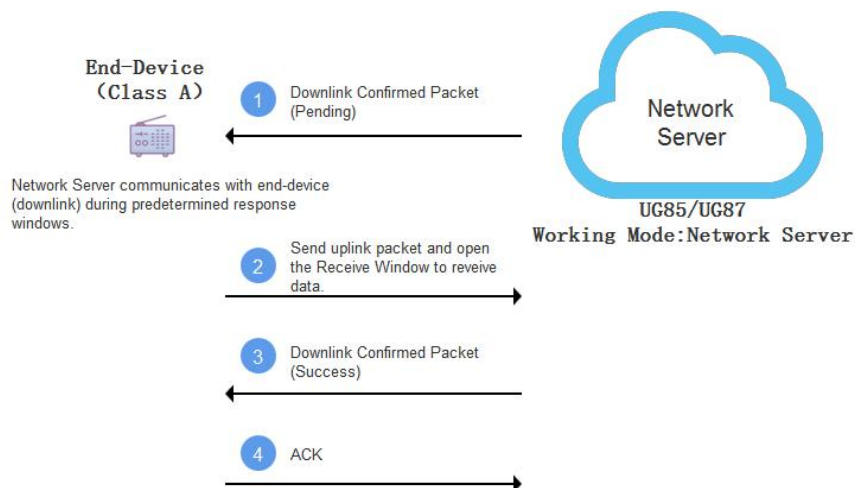

Network Server

Clear Search

Device EUI	Frequency	Datarate	SNR	RSSI	Size	Fcnt	Type	Time	Details
1122612191311123	868300000	SF10BW125	-	-	0	19	DnUnc	2019-08-06T09:49:38+08:00	!
1122612191311123	868300000	SF10BW125	10.8	-76	64	21	ACK	2019-08-06T09:49:38+08:00	!
1122612191311123	868300000	SF10BW125	10.8	-76	64	20	UpCnf	2019-08-06T09:49:38+08:00	!
1122612191311123	868100000	SF10BW125	-	-	6	18	DnCnf	2019-08-06T09:48:43+08:00	!
1122612191311123	868100000	SF10BW125	9.8	-77	64	20	UpCnf	2019-08-06T09:48:43+08:00	!
1122612191311123	0				6	18	DnCnf		!
1122612191311123	868500000	SF10BW125	-	-	0	17	DnUnc	2019-08-06T09:47:38+08:00	!
1122612191311123	868500000	SF10BW125	8.0	-76	64	19	UpCnf	2019-08-06T09:47:38+08:00	!
1122612191311123	868100000	SF10BW125	-	-	0	16	DnUnc	2019-08-06T09:46:38+08:00	!
1122612191311123	868100000	SF10BW125	11.2	-74	64	18	UpCnf	2019-08-06T09:46:37+08:00	!

Showing 51 to 60 of 355 rows rows per page Manual Refresh

means the device has received the packet you send.

Related Topic

[Packets](#)

4.11 Node-RED

4.11.1 Start the Node-RED

1. Go to "App > Node-RED" to enable the Node-RED feature.
2. After enabled, click "Launch" to go to the Node-RED web GUI and to log in with the same username and password as gateway.

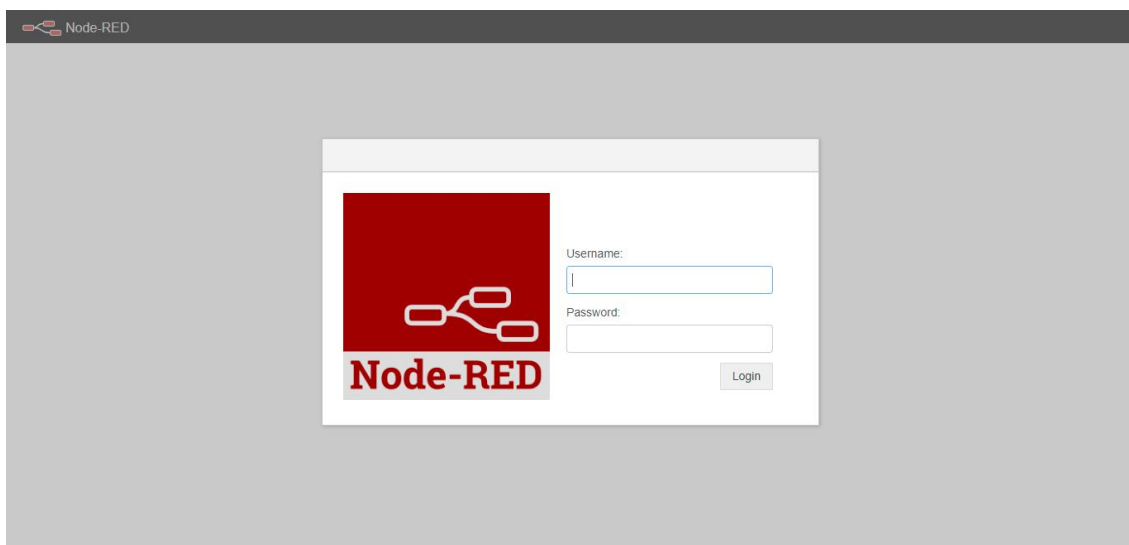

4.11.2 Send Data by Email

Application Example

Send AM104 device data by Email.

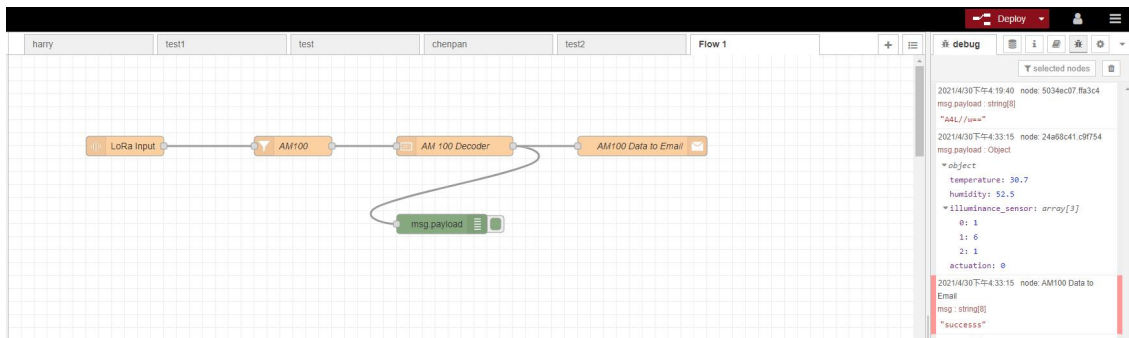

Configuration Steps

1. Add a “LoRa Input” node. Before adding please ensure network server mode is enabled and LoRaWAN devices have joined the network.
2. If you add many devices and only need one device data, add “Device Filter” node behind the “LoRa Input” and type the device EUI.

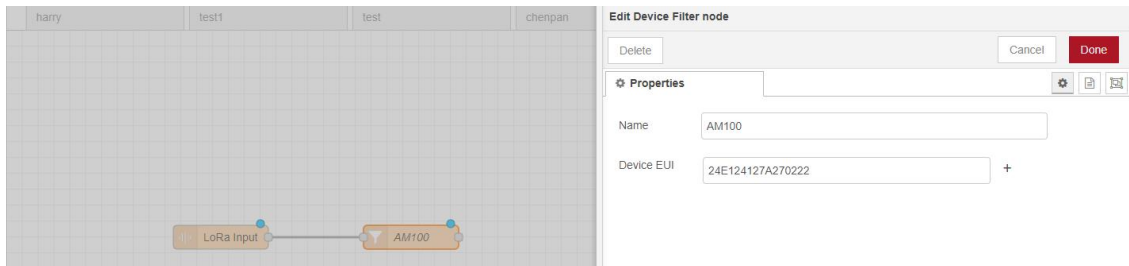

3. Add a “Decoder” node to decode the Milesight sensor data.

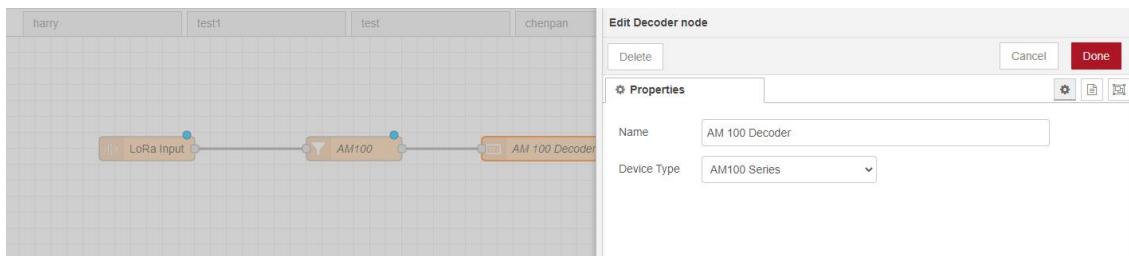

4. Add an “Email Output” and type the SMTP client settings, destination email address and contents. Example content:

The time is {{time}}

Deveui is {{deveui}}

Humidity is {{payload.humidity}}

The screenshot shows a Node-RED flow with the following nodes: LoRa Input, AM100, AM 100 Decoder, WAN Up, and msg payload. The 'AM 100 Decoder' node is connected to the 'AM100 Data to Email' node. The 'Edit Email Output node' properties panel is open, showing the following configuration:

- Name: AM100 Data to Email
- SMTP Option: Custom
- User ID: @milesight.com
- Password: [Redacted]
- SMTP Server Address: smtp.exmail.qq.com
- Port: 25
- Enable TLS:
- To: @milesight.com
- Topic: AM100 Data
- Payload: The time is {{time}}
Deveui is {{deveui}}
counter is {{payload.humidity}}

Note:

- 1) When you select SMTP Option as "Same as Gateway", go to "System -> General Settings -> SMTP" to configure the SMTP clients.
- 2) Basic format to call LoRaWAN node data is `{{property name}}`, you can click "Help" page for more info about the Email or SMS payload format.
- 3) If you need to check the output content in every node, please add debug node.
5. After completing the configuration, click "Deploy" to save all your configuration.

The screenshot shows the Node-RED interface with the flow configuration and the debug console. The flow consists of the following nodes: LoRa Input, AM100, AM 100 Decoder, AM100 Data to Email, and msg payload. The debug console shows the following output:

```

2021/4/30T09:13:13.872942Z node: 5034ec07.7a3c4
msg.payload: string[8]
"AA//v=="

```

6. When AM104 sends data to gateway, gateway will transfer the data to email.

The screenshot shows an email received from the gateway. The email header and body are as follows:

AM100 Data ★

2021-04-30

From: [Redacted]@milesight.com>
To: [Redacted]@milesight.com>
Time: 2021年4月30日 (周五) 17:13 🕒
Size: 2 KB

The time is 2021-04-30T09:13:13.872942Z Deveui is 24e124127a270222 Temperature is 30.4 Humidity is 52

Related Topic

[Node-RED](#)

[END]