

iSMA-B-4I40-H-IP

Installation Instructions

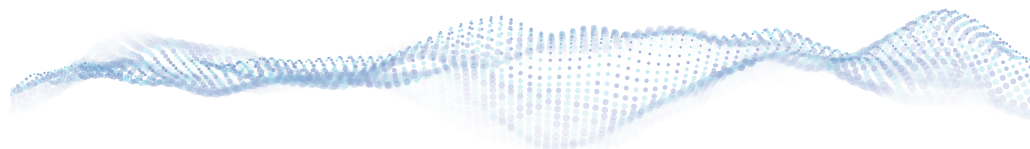

iSMA-B-4140-H-IP

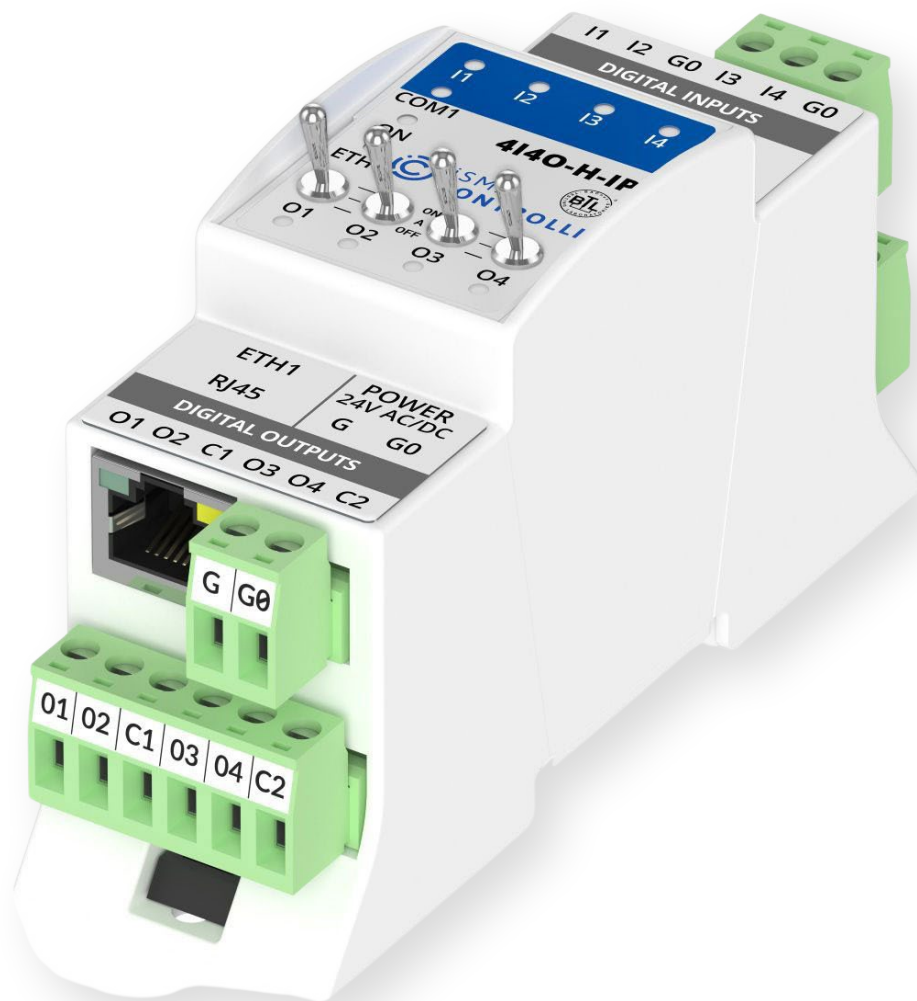

SPECIFICATION			
Power supply	DC: 24 V ± 20%, 2.2 W; AC: 24 V ± 20%, 3.3 VA		
Digital inputs	4x dry contact input, high-speed pulse counter up to 100 Hz		
Digital outputs	4x relay output	Maximum ratings	UL compliant ratings
	Resistive load max.	3 A @ 230 V AC	3 A @ 24 V AC
		3 A @ 30 V DC	3 A @ 30 V DC
Inductive load max.	75 VA @ 230 V AC	8 VA @ 24 V AC	
	30 W @ 30 V DC	30 W @ 30 V DC	
Interface	RS485 half-duplex: Modbus RTU/ASCII, up to 128 devices on the bus Ethernet: Modbus TCP/IP or BACnet/IP		
Address	Set by switch in range from 0 to 99		
Baudrate	Set by switch in range from 4800 to 115200 bps		
Ingress protection rating	IP40 - for indoor installation		
Temperature	Operating: -10°C to +50°C (14°F to 122°F) Storage: -40°C to +85°C (-40°F to 185°F)		
Relative humidity	5 to 95% RH (without condensation)		
Connectors	Separable, max 2.5 mm ² (18 - 12 AWG)		
Dimension	37x110x62 mm (1.45x4.33x2.44 in)		
Mounting	DIN rail mounting (DIN EN 50022 norm)		
Housing material	Plastic, self-extinguishing PC/ABS		

TOP PANEL

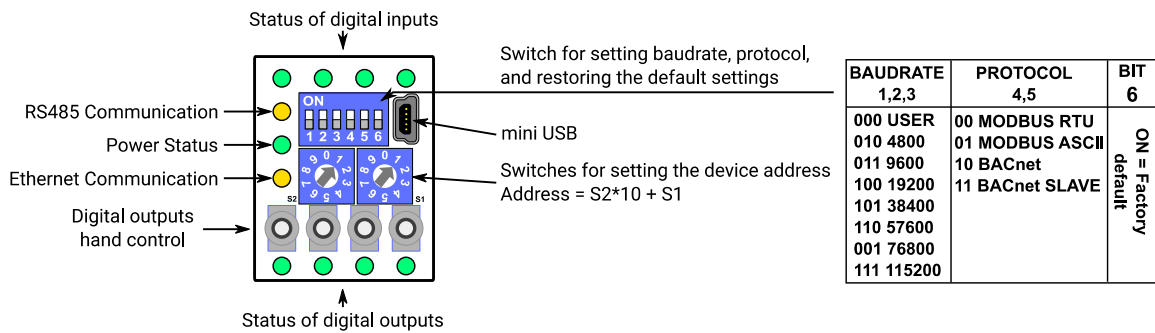

DIGITAL INPUTS

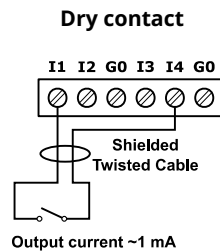

DIGITAL OUTPUTS

Connection of electrovalve

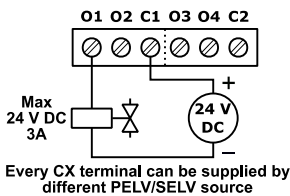

Connection of resistive load

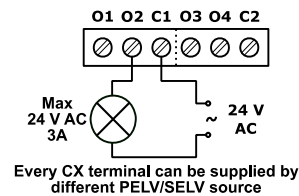

Connection of inductive load

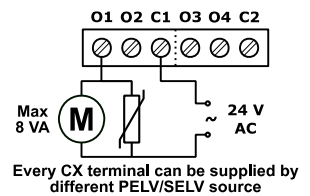

COMMUNICATION

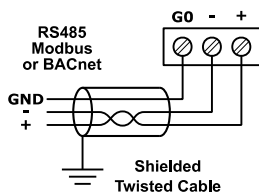

POWER SUPPLY

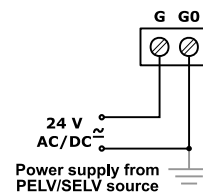

⚠ WARNING ⚠	TERMINALS OF THE DEVICE
<ul style="list-style-type: none"> • Note, an incorrect wiring of this product can damage it and lead to other hazards. Make sure the product has been correctly wired before turning the power ON. • Before wiring, or removing/mounting the product, be sure to turn the power OFF. Failure to do so might cause electric shock. • Do not touch electrically charged parts such as the power terminals. Doing so might cause electric shock. • Do not disassemble the product. Doing so might cause electric shock or faulty operation. • Use the product within the operating ranges recommended in the specification (temperature, humidity, voltage, shock, mounting direction, atmosphere etc.). Failure to do so might cause fire or faulty operation. • Firmly tighten the wires to the terminal. Insufficient tightening of the wires to the terminal might cause fire. 	

EN 60730-1 POWER SUPPLY CONSIDERATIONS

- Electrical safety in the building automation and control systems is essentially based on the use of extra low voltage which is strictly separated from the mains voltage. This low voltage is either SELV or PELV according to EN 60730-1.
- Protection against electric shock is ensured by the following measures:
 - limitation of voltage (low voltage AC/DC 24V supply, either SELV or PELV)
 - protective-separation of the SELV-system from all circuits other than SELV and PELV
 - simple-separation of the SELV-system from other SELV-systems, from PELV-systems and earth
- Field devices such as sensors, status contacts and actuators connected to the low-voltage inputs and outputs of I/O modules must comply with the requirements for SELV or PELV. The interfaces of field devices and other systems must also satisfy SELV or PELV requirements.
- When the supply of SELV or PELV circuits is obtained from supply mains of higher voltages it shall be provided by safety transformer or a converter designed for continuous operation to supply SELV or PELV circuits.

FCC COMPLIANCE NOTE

Note: This equipment has been tested and found to comply with the limits for a Class B digital device, pursuant to part 15 of the FCC Rules. These limits are designed to provide reasonable protection against harmful interference in a residential installation. This equipment generates, uses and can radiate radio frequency energy and, if not installed and used in accordance with the instructions, may cause harmful interference to radio communications. However, there is no guarantee that interference will not occur in a particular installation. If this equipment does cause harmful interference to radio or television reception, which can be determined by turning the equipment off and on, the user is encouraged to try to correct the interference by one or more of the following measures:

- Reorient or relocate the receiving antenna.
- Increase the separation between the equipment and receiver.
- Connect the equipment into an outlet on a circuit different from that to which the receiver is connected.
- Consult the dealer or an experienced radio/TV technician for help.

WIRING

- Line power cables must be routed with spatial separation from signal and data transmission cables.
- Analogue and digital signal cables should also be separated.
- It is recommended to use shielded cables for analogue signals, cable shields should not be interrupted by intermediate terminals.
- The shielding should be earthed directly after the cable enters the cabinet.
- It is recommended to install interference suppressors when switching inductive loads (e.g. coils of contactors, relays, solenoid valves). RC snubbers or varistors are suitable for AC voltage and freewheeling diodes for DC voltage loads. The suppressing elements must be connected as close to the coil as possible



Please read the instruction before use or operating the device. In case of any questions after reading this document, please contact the iSMA CONTROLLI Support Team (support@ismacontrolli.com).



- Before wiring or removing/mounting the product, make sure to turn the power off. Failure to do so might cause an electric shock.
- Improper wiring of the product can damage it and lead to other hazards. Make sure that the product has been correctly wired before turning the power on.
- Do not touch electrically charged parts such as power terminals. Doing so might cause an electric shock.

• Do not disassemble the product. Doing so might cause an electric shock or faulty operation.



- Use the product only within the operating ranges recommended in the specification (temperature, humidity, voltage, shock, mounting direction, atmosphere, etc.). Failure to do so might cause a fire or faulty operation.

- Firmly tighten the wires to the terminal. Failure to do so might cause a fire.

- Avoid installing the product in close proximity to high-power electrical devices and cables, inductive loads, and switching devices. Proximity of such objects may cause an uncontrolled interference, resulting in an instable operation of the product.
- Proper arrangement of the power and signal cabling affects the operation of the entire control system. Avoid laying the power and signal wiring in parallel cable trays. It can cause interferences in monitored and control signals.
- It is recommended to power controllers/modules with AC/DC power suppliers. They provide better and more stable insulation for devices compared to AC/AC transformer systems, which transmit disturbances and transient phenomena like surges and bursts to devices. They also isolate products from inductive phenomena from other transformers and loads.
- Power supply systems for the product should be protected by external devices limiting overvoltage and effects of lightning discharges.
- Avoid powering the product and its controlled/monitored devices, especially high power and inductive loads, from a single power source. Powering devices from a single power source causes a risk of introducing disturbances from the loads to the control devices.
- If an AC/AC transformer is used to supply control devices, it is strongly recommended to use a maximum 100 VA Class 2 transformer to avoid unwanted inductive effects, which are dangerous for devices.
- Long monitoring and control lines may cause loops in connection with the shared power supply, causing disturbances in the operation of devices, including external communication. It is recommended to use galvanic separators.
- To protect signal and communication lines against external electromagnetic interferences, use properly grounded shielded cables and ferrite beads.
- Switching the digital output relays of large (exceeding specification) inductive loads can cause interference pulses to the electronics installed inside the product. Therefore, it is recommended to use external relays/contactors, etc. to switch such loads. The use of controllers with triac outputs also limits similar overvoltage phenomena.
- Many cases of disturbances and overvoltage in control systems are generated by switched, inductive loads supplied by alternating mains voltage (AC 120/230 V). If they do not have appropriate built-in noise reduction circuits, it is recommended to use external circuits such as snubbers, varistors, or protection diodes to limit these effects.



Electrical installation of this product must be done in accordance with national wiring codes and conform to local regulations.